



## Investor Relations



IR PRESENTATION:  
April 2026

NASDAQ:SIDU | SIDUSSPACE.COM



**Multi-Orbit. All Domain.**  
Mission-Driven.  
End-to-End. Trusted.

Sidus Space is an innovative space and defense technology company with core capabilities that include dual use **satellite manufacturing & technology integration, AI products and services, space and defense hardware components and space-based data solutions.**

With deep heritage in flight-proven technologies, Sidus' portfolio spans LEO, GEO and Lunar satellites, all-domain avionics & GN&C systems, RF payloads, high-performance computing, multi-disciplinary engineering services, and artificial intelligence technologies.

### Vertical Integration

- Full tech-stack solutions from design to deployment

### AI Driven Ecosystem

- Orlaith™: FeatherEdge™ hardware + Cielo™ software for autonomous operations

### Space Platforms

- LizzieSat®, GEOLizzie™, LunarLizzie™

### All Domain Platforms

- Fortis™ VPX computing systems for air, land, sea & space

### Innovation

- 30 patents (15 published, 15 + pending)

### Engineering

- Multi-disciplinary expertise for technology advancement

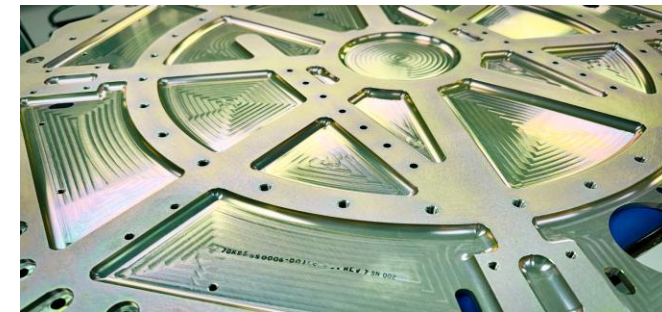

# Sidus Space Growth and Timeline

2025



2026

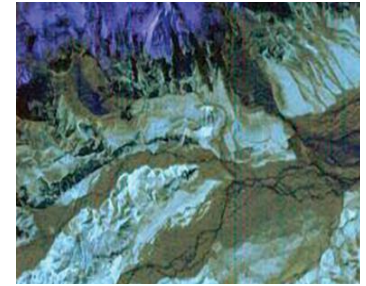

## 2025

### Satellite Milestones

- Launched LizzieSat® - 3, March 14, 2025, which featured data integration with Sidus Orlaith™ enabling on-orbit data processing for critical applications such as Space Situational Awareness (SSA), maritime monitoring, and disaster response
- Multi-purpose, multi-mission, micro-constellation
- Space-to-Space data relay module
- Lonestar contract - first lunar satellite opportunity
- LizzieSat®-1 completed initial NASA ASTRA mission and signed a follow up contract to continue through the life of the satellite

## 2025

### Products and Partnerships

- Focus on core pillars of Sidus: Technology, AI and Space
- Fortis™ VPX in production & entering the market
- ALEM™ FlatSat (Adaptable LizzieSat® Engineering Model) Lab-based integration and test-bed platform
- In-orbit demonstrations and algorithms that provide near real-time, autonomous Intelligence, Surveillance, and Reconnaissance (ISR) tasking and execution
- ML2 enclosure deliveries
- Navy trainer delivery
- Sidus International Space Center

## 2026

### Satellite Milestones

- LizzieSat® - 3 Technology commissioning
- LizzieSat® - 4 & 5 gen-1 platform with software-defined systems
- LoneStar Commercial Pathfinder Mission integration
- LizzieSat® - 6 gen-2 platform design
- The Netherlands Organization HemiCat integration– a high-efficiency miniature communications laser terminal

## 2026

### Products and Partnerships

- VPX/SOSA® LizzieSat® flight heritage
- Software defined multi-spectral imagery integration
- In-orbit demonstrations and algorithms that provide near real-time, autonomous Intelligence, Surveillance, and Reconnaissance (ISR) tasking and execution

**Actively pursuing multiple international and lunar opportunities alongside major government infrastructure projects across all business segments**

# Key Leadership and Personnel



**Carol Craig**

Founder & Chief Executive Officer



**Adarsh Parekh**

Chief Financial Officer



**Mark Mikolajczyk**

Chief Operations Officer



**Valerij Ojdanic**

Chief Technology Officer



**John Roy**

Chief Human Resources Officer



**Patrick Butler**

SVP | Engineering & Programs



**Jim Larson**

SVP | AI Strategic Initiatives



**Matthew Fiore**

Director | Business Development





## Selected by Missile Defense Agency for SHIELD

Indefinite delivery/indefinite quantity (IDIQ) contract from the MDA awarded in Q4 2025 for the Scalable Homeland Innovative Enterprise Layered Defense (SHIELD) program.

**\$151 billion shared contract ceiling**

**Positions Sidus Space to support the full lifecycle from concept development to operational deployment. Our capabilities directly support the following SHIELD focus areas:**

- Research and Development
- Studies, Demonstrations, Testing of Prototypes
- Modeling, Simulation, and Analysis
- Production and Fielding

# Scaling the World's First Commercial Space-based Data Storage Service

---

- **Agreement Expansion:** Sidus has expanded its relationship with Lonestar Data Holdings, Inc. to build and deliver an additional StarVault orbital data storage payload.
- **Operational Milestone:** This amendment marks the transition of Lonestar's StarVault from early missions to sustained commercial deployment.
- **Upcoming Launch:** Sidus is currently developing the first StarVault payload, scheduled to launch no earlier than Fall 2026.



## Strategic Partnerships & Growth

- **HEO USA's On-Orbit Imagery Milestone:** LizzieSat-3 successfully captured on-orbit imagery for HEO USA, validating integrated sensor performance and advancing multi-sensor commercial operations toward revenue-generating service delivery.
- **Simera Sense MOU:** Sidus Space entered a strategic MOU with Simera Sense to develop AI-enabled hyperspectral missions, advancing onboard processing and near-real-time Earth observation capabilities.
- **Maris-Tech's Integration Milestone:** Sidus Space achieved a key integration milestone with Maris-Tech for the LizzieSat-4 mission, advancing payload testing and platform readiness ahead of the anticipated 2026 launch.

LIZZIESAT | 36° 08'06.0" S 141° 54'04.3" E  
VICTORIA, AUSTRALIA





### Full Stack Capabilities

- ✓ Hardware, software, and data services in house

### Defense-Grade Agility

- ✓ Rapid design, production, and deployment

### Mission-aligned Solutions

- ✓ Supporting government priorities across defense, transportation, and space

### Proven Execution

- ✓ Trusted partner for NASA, DoD, and commercial aerospace clients

## Customers



## Products and Solutions for All Domains

### Satellite Manufacturing and Technology Integration



- LizzieSat® (LS1 – LS3)
- LizzieSat® Gen 2 (LS4+)
- LunarLizzie™
- GEOLizzie™
- Technology integration

### Mission Operations



- End-to-end mission operations
- Advanced security and infrastructure
- Mission engineering and planning support

### AI/ML Products and Services



- Orraith™ AI Ecosystem
- FeatherEdge™ AI/ML processor
- Cielo™ software suite
- AI-driven space-based data and insights

### Space and Defense Hardware Manufacturing

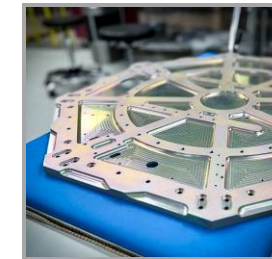

- Multi-disciplinary engineering services
- Precision machining
- Welding
- Avionics and cable wire harness assemblies
- Assembly, Integration and Test

### Critical Subsystems and Components

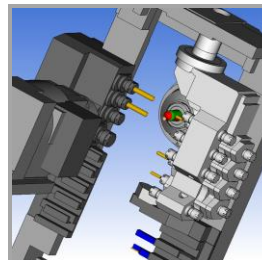

- Fortis™ VPX Maxima, Flex, and Delta Systems
- Sidus SBC
- Sidus PNT
- Critical design engineering and support

### Technology and Patents

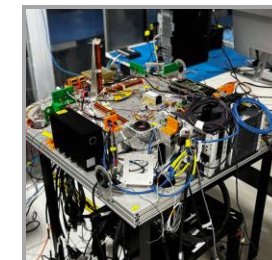

- Modular Satellite Testing Platform System
- Modular Satellite C&DH System
- Proprietary 3D Printed Satellite Architecture
- EMI Filter Unit



# Why Sidus, Why Now: Multi-Orbit, All Domain Positioned for Scalable Growth

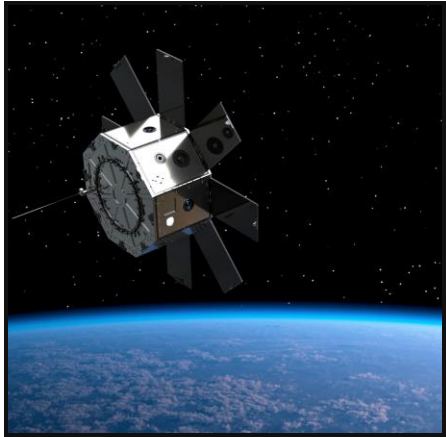

## Commercialization

- ✓ Shifted from legacy engineering services to satellite manufacturing, space-based data, and AI services
- ✓ Scalable micro constellation with rapid production and deployment
- ✓ Recurring data-as-a-service
- ✓ Constellation approval

## Vertical Integration

- ✓ Design and manufacturing, engineering services, technology integration, satellite operations, and data solutions in-house
- ✓ Hardware, software, and data services in-house
- ✓ Mission Control Center
- ✓ Clean Room

## All Domain Technologies

- ✓ Technologies supporting air, land, sea, and space
- ✓ Orlaith™ AI Ecosystem, FeatherEdge™, and Cielo™ Software Suite
- ✓ Fortis™ Maxima, Sidus Single Board Computer (SSBC), Sidus Position, Navigation, and Timing Module (PNT)

# Technology and IP

## Over 30 Patents

Sidus Space's commitment to innovation is evidenced by its robust patent portfolio, demonstrating innovation in key areas of aerospace and space technology

- LizzieSat®
- Fortis™ - Command and Data Handling VPX System
- Print Head for Regolith-Polymer Mixture
- Electromagnetic Interference (EMI) Filter Unit
- 3D Print Head Apparatus
- Vertical Takeoff and Landing Pad Interlocking Pavers
- Heat Transfer System
- High-load Vacuum Chamber Motion Feedthrough Systems
- EFTP – External Flight Test Platform
- Phoenix – Cube Satellite Space Deployer System

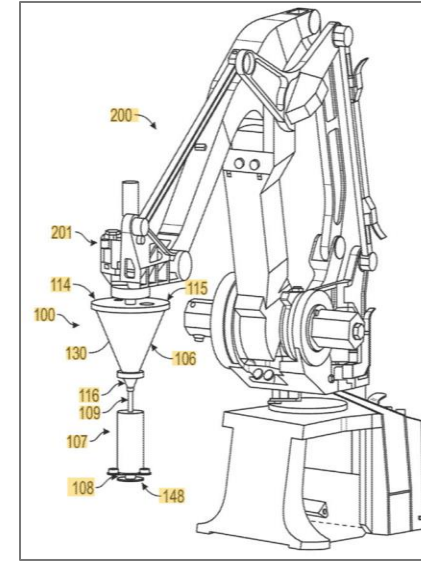

### Regolith-Polymer 3D Printing

The invention consists of a 3D print head apparatus that heats and extrudes a regolith-polymer (or other) mixture as part of an additive manufacturing process.



### Command and Data Handling VPX System

This is a flexible system designed to allow for reconfigurable internal components based on specific mission needs, thereby improving processing efficiency, scalability, and payload integration

# LIZZIESAT®

Multi-Mission  
Multi-Sensor

## Hybrid 3D-Printed

LizzieSat® is a highly adaptable satellite bus platform engineered to support a wide range of mission profiles, including in-orbit demonstrations, Earth observation, technology validation, and microgravity research.

Built with flight-proven subsystems, LizzieSat® delivers reliable remote sensing capabilities and actionable data to a diverse customer base across commercial, government, defense, and intelligence sectors.

### LizzieSat® Gen 1

100 – 125 kg

### LizzieSat® Gen 2

100, 200, and 400 kg

### GEOLizzie™

400-800kg

### LunarLizzie™

400-800kg

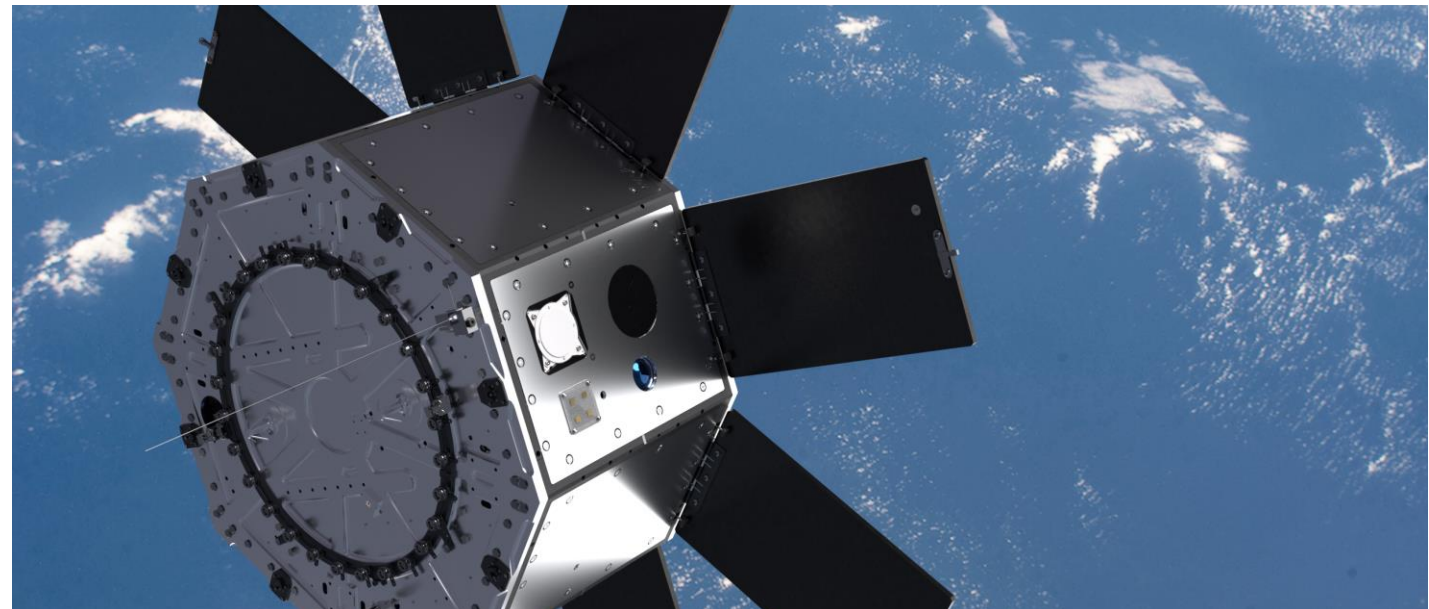

### LizzieSat®-1 (LS1)

March 4, 2024  
Transporter-10 | Vandenberg SFB



### LizzieSat®-2 (LS2)

December 21, 2024  
Bandwagon-2 | Vandenberg SFB



### LizzieSat®-3 (LS3)

March 14, 2025  
Transporter-13 | Vandenberg SFB

# Orlaith™ AI Ecosystem

Positioned for Scalable Growth



## Orlaith™ AI Ecosystem

The Orlaith™ AI Ecosystem integrates advanced artificial intelligence and machine learning hardware, software, and algorithms into a unified platform designed for air, land, sea, and space operations.

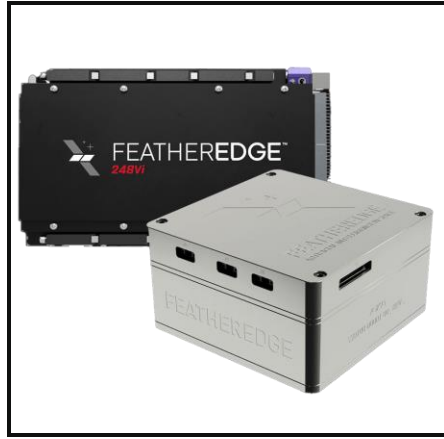

## FeatherEdge™

FeatherEdge™ is a high-performance AI/ML processor and the hardware component of the Orlaith™ AI Ecosystem, delivering near real-time data processing, rapid decision-making, and system resilience in extreme environments and size-constrained applications.



## Cielo™

Cielo™, the software component of the Orlaith™ AI Ecosystem, harnesses the power of AI, machine learning, and data fusion to deliver near real-time intelligence through advanced algorithms and processing capabilities.



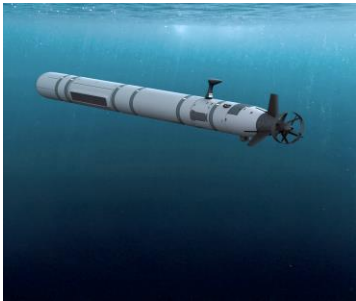

# FORTIS™

Fortis™ VPX is a command and data handling (C&DH) system, fully aligned with both SOSA® / MOSA® technical standards, ensuring open architecture capabilities across mission-critical systems.

**The Fortis™ VPX suite includes the following product line options:**

- Sidus Single Board Computer (SSBC)
- FeatherEdge™ AI/ML Processor
- Sidus Position, Navigation, and Timing Module (PNT)
- Global Positioning System (GPS) Receiver
- Custom Input/Output (I/O) Card
- Power Converter Card
- Third Party Software Defined Radio (SDR)

## Fortis™ Applications Examples

### **Air**

- Aerial Drones
- Ballistic Missiles
- Commercial and Civil Aircraft

### **Land**

- Command and Control (C2) Network
- Electronic Warfare (EW)
- Intelligence, Surveillance, and Reconnaissance (ISR)
- Unmanned Ground Vehicles (UGVs)

### **Sea**

- Submarines
- Surface Ships
- Underwater Drones

### **Space**

- Counterspace Operations
- Satellites
- Space Defense
- Space Situational Awareness

# Company Revenue

## Diverse Company Wide Revenue

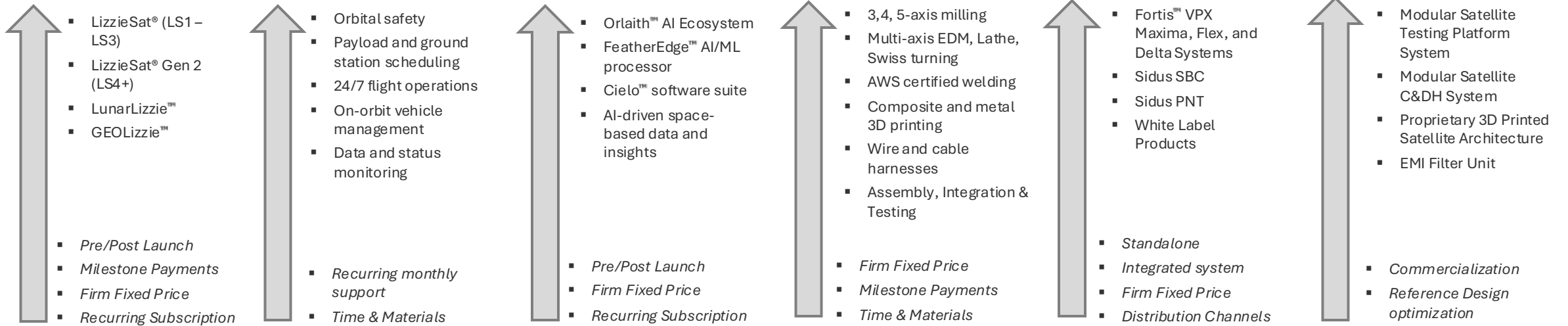

### Satellite Manufacturing and Technology Integration

Design, assembly, integration, and testing of innovative satellite platforms, offering customized solutions for various missions and clients, leveraging advanced manufacturing techniques such as hybrid 3D printing

### Mission Operations

24/7 mission-critical command, control, and data management services for satellites and payloads, ensuring reliable and efficient operations throughout a mission's lifecycle.

### AI/ML Products, Services and Data

Development and deployment of artificial intelligence and machine learning solutions for enhanced satellite data analysis, intelligent tasking, and optimization of space-based operations and applications.

### Space and Defense Hardware Manufacturing

Precision manufacturing of high-reliability hardware, components, and full systems for both commercial space and national defense applications, meeting stringent industry standards.

### Critical Subsystems and Components

Production and sales of specialized, high-performance subsystems and individual components essential for satellite functionality, avionics, and other space and defense-grade equipment.

### Technology and Patents

Monetization of proprietary intellectual property, including licensing of innovative technologies, software, and patented designs developed to advance space exploration and utilization.

# Financials



## Key Metrics & Momentum

**Operating Leverage:** Even at an early stage, Sidus has developed an expansive platform and technology portfolio while maintaining stable operating expenses

**Poised for Growth:** Third satellite launch in under a year, with programs like Lonestar indicating strong near- and long-term revenue potential

**Strengthened Balance Sheet:** Raised \$53MM in 2025, positioning Sidus to pursue high-impact market opportunities

**Cost Efficiency:** Total cost per satellite has dropped significantly; LizzieSat<sup>®</sup>-3 is nearly 50% more cost-efficient than LizzieSat<sup>®</sup>-1

**Strategic Flexibility:** Healthy cash position and low leverage equip Sidus to scale quickly into emerging national security and infrastructure initiatives

Sidus continues to strengthen its position through disciplined growth, demonstrated heritage, expanded contracts, and a vertically integrated model designed to scale with mission-critical demand.

	Twelve Months Ended	
	December 31, 2025	December 31, 2024
<b>Revenues</b>	\$3,383,878	\$4,672,646
<b>Cost of Revenue</b>	\$9,076,445	\$6,141,657
<b>Gross Profit (Loss)</b>	<b>\$(5,692,567)</b>	<b>\$(1,469,011)</b>
<b>Total Operating Expenses</b>	\$22,315,569	\$14,249,870
<b>Other Income (Expenses)</b>	\$(1,466,168)	\$(1,805,175)
<b>Net Loss</b>	<b>\$(29,474,304)</b>	<b>\$(17,524,056)</b>

Capitalization Table as of March 31, 2026	
<b>Class A Stock</b>	66,419,852
<b>Class B Stock</b>	100,000
<b>Options (WAEP: \$11.58)</b>	64,552
<b>Warrants (WAEP: \$2.23)</b>	3,981,127
<b>Fully Diluted Shares Outstanding</b>	<b>70,565,531</b>



## Contact Us:

### Investors Relations

Adarsh Parekh, Chief Financial Officer

+1 321.450.5633 (option 1)

Investor-relations@siduspace.com

### Transfer Agent

Pacific Stock Transfer Company

6725 Via Austi Pkwy Suite 300

Las Vegas, NV, USA 89119

+1 702.361.3033 x 111

