



Investor Relations



IR PRESENTATION:
April 2026

NASDAQ:SIDU | SIDUSSPACE.COM



Multi-Orbit. All Domain.
Mission-Driven.
End-to-End. Trusted.

Sidus Space is an innovative space and defense technology company with core capabilities that include dual use **satellite manufacturing & technology integration, AI products and services, space and defense hardware components and space-based data solutions.**

With deep heritage in flight-proven technologies, Sidus' portfolio spans LEO, GEO and Lunar satellites, all-domain avionics & GN&C systems, RF payloads, high-performance computing, multi-disciplinary engineering services, and artificial intelligence technologies.

Vertical Integration

- Full tech-stack solutions from design to deployment

AI Driven Ecosystem

- Orlaith™: FeatherEdge™ hardware + Cielo™ software for autonomous operations

Space Platforms

- LizzieSat®, GEOLizzie™, LunarLizzie™

All Domain Platforms

- Fortis™ VPX computing systems for air, land, sea & space

Innovation

- 30 patents (15 published, 15 + pending)

Engineering

- Multi-disciplinary expertise for technology advancement

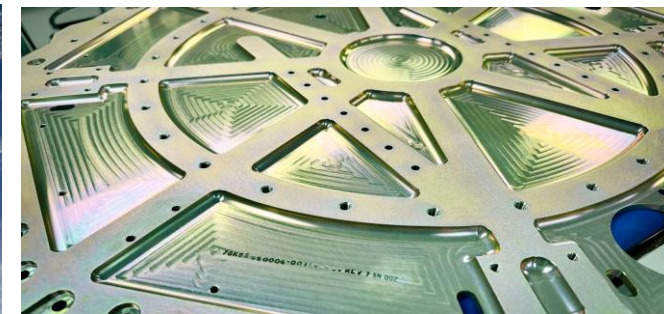
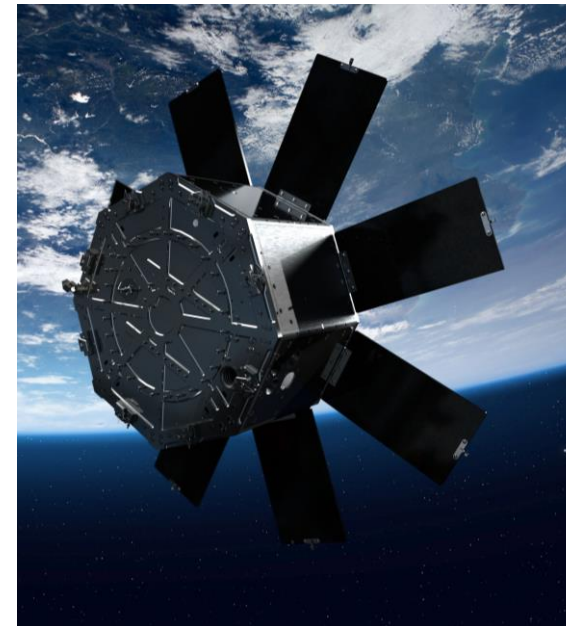

Sidus Space Growth and Timeline

2025



2026

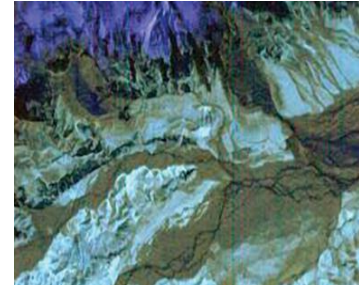

2025

Satellite Milestones

- Launched LizzieSat® - 3, March 14, 2025, which featured data integration with Sidus Orlaith™ enabling on-orbit data processing for critical applications such as Space Situational Awareness (SSA), maritime monitoring, and disaster response
- Multi-purpose, multi-mission, micro-constellation
- Space-to-Space data relay module
- Lonestar contract - first lunar satellite opportunity
- LizzieSat®-1 completed initial NASA ASTRA mission and signed a follow up contract to continue through the life of the satellite

2025

Products and Partnerships

- Focus on core pillars of Sidus: Technology, AI and Space
- Fortis™ VPX in production & entering the market
- ALEM™ FlatSat (Adaptable LizzieSat® Engineering Model) Lab-based integration and test-bed platform
- In-orbit demonstrations and algorithms that provide near real-time, autonomous Intelligence, Surveillance, and Reconnaissance (ISR) tasking and execution
- ML2 enclosure deliveries
- Navy trainer delivery
- Sidus International Space Center

2026

Satellite Milestones

- LizzieSat® - 3 Technology commissioning
- LizzieSat® - 4 & 5 gen-1 platform with software-defined systems
- LoneStar Commercial Pathfinder Mission integration
- LizzieSat® - 6 gen-2 platform design
- The Netherlands Organization HemiCat integration— a high-efficiency miniature communications laser terminal

2026

Products and Partnerships

- VPX/SOSA® LizzieSat® flight heritage
- Software defined multi-spectral imagery integration
- In-orbit demonstrations and algorithms that provide near real-time, autonomous Intelligence, Surveillance, and Reconnaissance (ISR) tasking and execution

Actively pursuing multiple international and lunar opportunities alongside major government infrastructure projects across all business segments

Key Leadership and Personnel



Carol Craig

Chief Executive Officer
& Founder



Adarsh Parekh

Chief Financial Officer



Mark Mikolajczyk

Chief Operations Officer



Valerij Ojdanic

Chief Technology Officer



John Roy

Chief Human Resources Officer



Jim Larson

SVP AI Strategic Initiatives



Patrick Butler

EVP, Engineering & Programs





Full Stack Capabilities

- ✓ Hardware, software, and data services in house

Defense-Grade Agility

- ✓ Rapid design, production, and deployment

Mission-aligned Solutions

- ✓ Supporting government priorities across defense, transportation, and space

Proven Execution

- ✓ Trusted partner for NASA, DoD, and commercial aerospace clients

Customers



Products and Solutions for All Domains

Satellite Manufacturing and Technology Integration



- LizzieSat® (LS1 – LS3)
- LizzieSat® Gen 2 (LS4+)
- LunarLizzie™
- GEOLizzie™
- Technology integration

Mission Operations



- End-to-end mission operations
- Advanced security and infrastructure
- Mission engineering and planning support

AI/ML Products and Services



- Orlaith™ AI Ecosystem
- FeatherEdge™ AI/ML processor
- Cielo™ software suite
- AI-driven space-based data and insights

Space and Defense Hardware Manufacturing

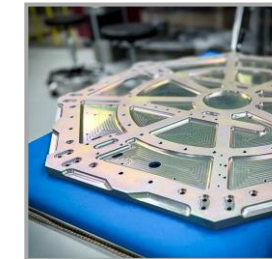

- Multi-disciplinary engineering services
- Precision machining
- Welding
- Avionics and cable wire harness assemblies
- Assembly, Integration and Test

Critical Subsystems and Components

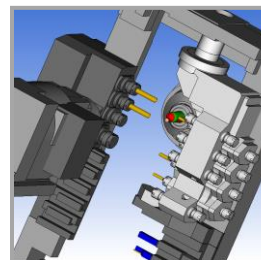

- Fortis™ VPX Maxima, Flex, and Delta Systems
- Sidus SBC
- Sidus PNT
- Critical design engineering and support

Technology and Patents

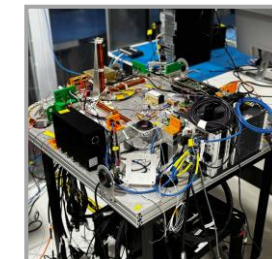

- Modular Satellite Testing Platform System
- Modular Satellite C&DH System
- Proprietary 3D Printed Satellite Architecture
- EMI Filter Unit

Why Sidus, Why Now: Multi-Orbit, All Domain Positioned for Scalable Growth



Commercialization

- ✓ Shifted from legacy engineering services to satellite manufacturing, space-based data, and AI services
- ✓ Scalable micro constellation with rapid production and deployment
- ✓ Recurring data-as-a-service
- ✓ Constellation approval

Vertical Integration

- ✓ Design and manufacturing, engineering services, technology integration, satellite operations, and data solutions in-house
- ✓ Hardware, software, and data services in-house
- ✓ Mission Control Center
- ✓ Clean Room

All Domain Technologies

- ✓ Technologies supporting air, land, sea, and space
- ✓ Orlaith™ AI Ecosystem, FeatherEdge™, and Cielo™ Software Suite
- ✓ Fortis™ Maxima, Sidus Single Board Computer (SSBC), Sidus Position, Navigation, and Timing Module (PNT)

Technology and IP

Over 30 Patents

Sidus Space's commitment to innovation is evidenced by its robust patent portfolio, demonstrating innovation in key areas of aerospace and space technology

- LizzieSat®
- Fortis™ - Command and Data Handling VPX System
- Print Head for Regolith-Polymer Mixture
- Electromagnetic Interference (EMI) Filter Unit
- 3D Print Head Apparatus
- Vertical Takeoff and Landing Pad Interlocking Pavers
- Heat Transfer System
- High-load Vacuum Chamber Motion Feedthrough Systems
- EFTP – External Flight Test Platform
- Phoenix – Cube Satellite Space Deployer System

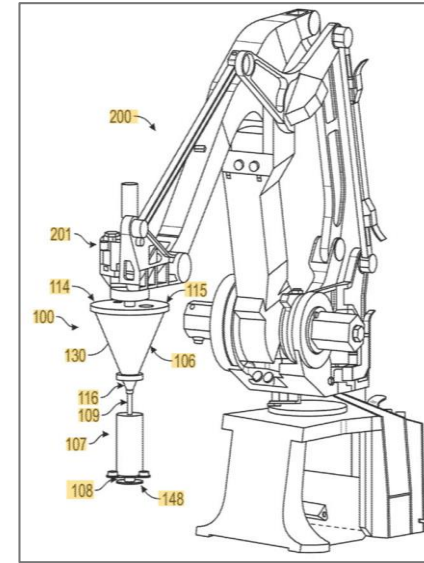

Regolith-Polymer 3D Printing

The invention consists of a 3D print head apparatus that heats and extrudes a regolith-polymer (or other) mixture as part of an additive manufacturing process.



Command and Data Handling VPX System

This is a flexible system designed to allow for reconfigurable internal components based on specific mission needs, thereby improving processing efficiency, scalability, and payload integration

LIZZIESAT®

Multi-Mission

Multi-Sensor

Hybrid 3D-Printed

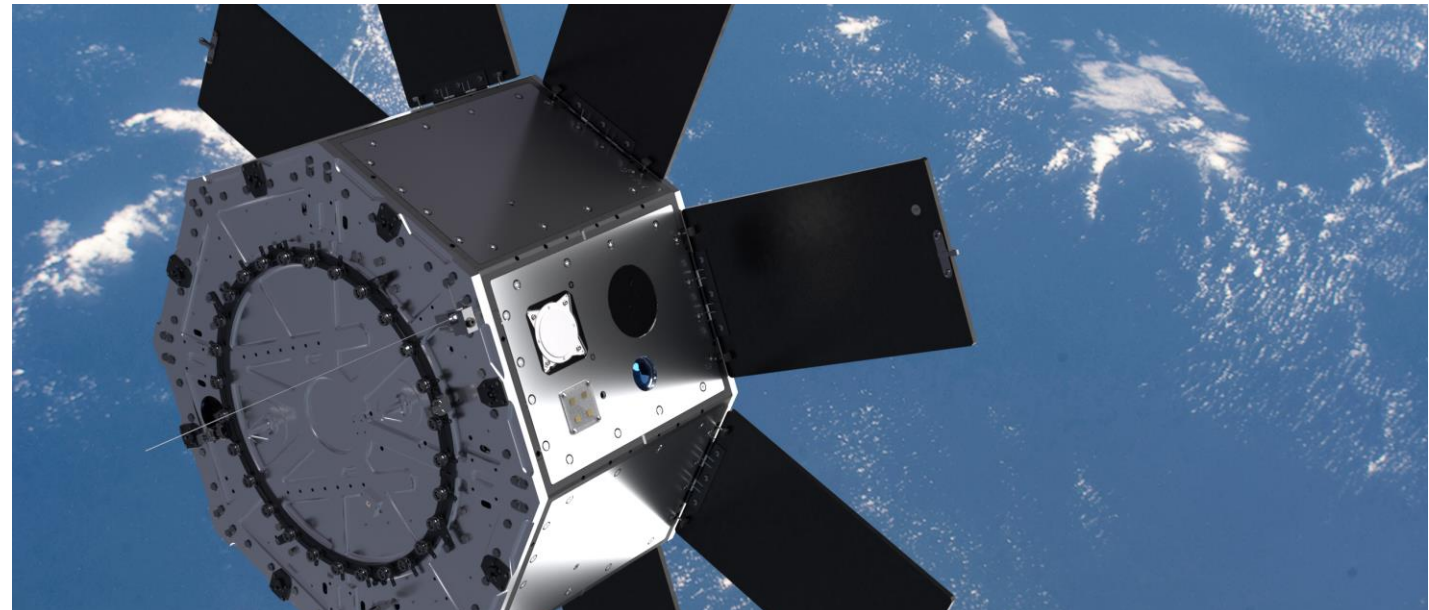

LizzieSat® is a highly adaptable satellite bus platform engineered to support a wide range of mission profiles, including in-orbit demonstrations, Earth observation, technology validation, and microgravity research.

Built with flight-proven subsystems, LizzieSat® delivers reliable remote sensing capabilities and actionable data to a diverse customer base across commercial, government, defense, and intelligence sectors.

LizzieSat® Gen 1

100 – 125 kg

LizzieSat® Gen 2

100, 200, and 400 kg

GEOLizzie™

400-800kg

LunarLizzie™

400-800kg



LizzieSat®-1 (LS1)

March 4, 2024
Transporter-10 | Vandenberg SFB



LizzieSat®-2 (LS2)

December 21, 2024
Bandwagon-2 | Vandenberg SFB



LizzieSat®-3 (LS3)

March 14, 2025
Transporter-13 | Vandenberg SFB

Orlaith™ AI Ecosystem

Positioned for Scalable Growth



Orlaith™ AI Ecosystem

The Orlaith™ AI Ecosystem integrates advanced artificial intelligence and machine learning hardware, software, and algorithms into a unified platform designed for air, land, sea, and space operations.



FeatherEdge™

FeatherEdge™ is a high-performance AI/ML processor and the hardware component of the Orlaith™ AI Ecosystem, delivering near real-time data processing, rapid decision-making, and system resilience in extreme environments and size-constrained applications.



Cielo™

Cielo™, the software component of the Orlaith™ AI Ecosystem, harnesses the power of AI, machine learning, and data fusion to deliver near real-time intelligence through advanced algorithms and processing capabilities.



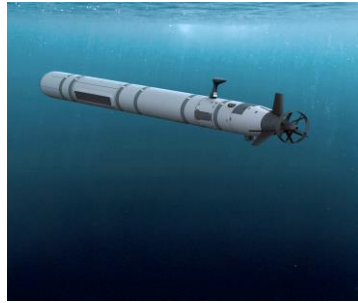

FORTIS™

Fortis™ VPX is a command and data handling (C&DH) system, fully aligned with both SOSA® / MOSA® technical standards, ensuring open architecture capabilities across mission-critical systems.

The Fortis™ VPX suite includes the following product line options:

- Sidus Single Board Computer (SSBC)
- FeatherEdge™ AI/ML Processor
- Sidus Position, Navigation, and Timing Module (PNT)
- Global Positioning System (GPS) Receiver
- Custom Input/Output (I/O) Card
- Power Converter Card
- Third Party Software Defined Radio (SDR)

Fortis™ Applications Examples

Air

- Aerial Drones
- Ballistic Missiles
- Commercial and Civil Aircraft

Sea

- Submarines
- Surface Ships
- Underwater Drones

Land

- Command and Control (C2) Network
- Electronic Warfare (EW)
- Intelligence, Surveillance, and Reconnaissance (ISR)
- Unmanned Ground Vehicles (UGVs)

Space

- Counterspace Operations
- Satellites
- Space Defense
- Space Situational Awareness

Company Revenue

Diverse Company Wide Revenue

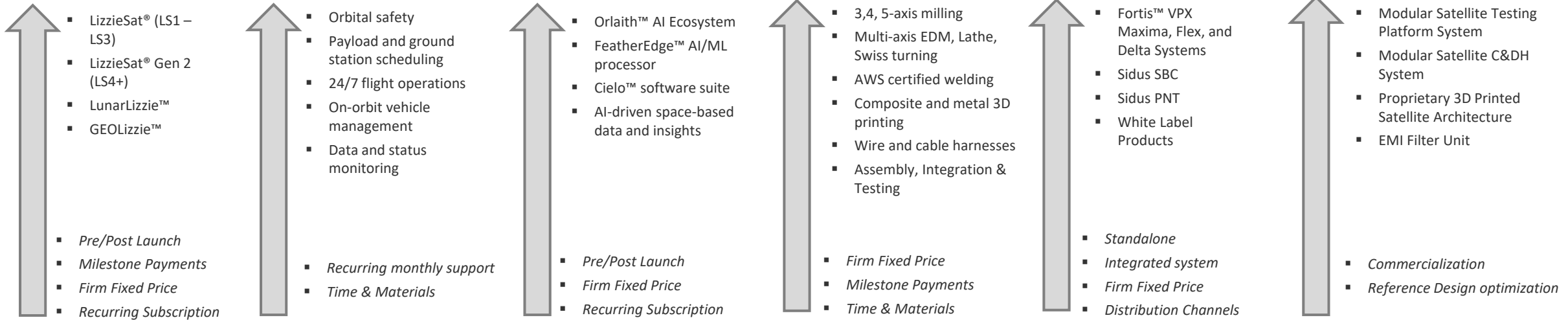

Satellite Manufacturing and Technology Integration

Design, assembly, integration, and testing of innovative satellite platforms, offering customized solutions for various missions and clients, leveraging advanced manufacturing techniques such as hybrid 3D printing

Mission Operations

24/7 mission-critical command, control, and data management services for satellites and payloads, ensuring reliable and efficient operations throughout a mission's lifecycle.

AI/ML Products, Services and Data

Development and deployment of artificial intelligence and machine learning solutions for enhanced satellite data analysis, intelligent tasking, and optimization of space-based operations and applications.

Space and Defense Hardware Manufacturing

Precision manufacturing of high-reliability hardware, components, and full systems for both commercial space and national defense applications, meeting stringent industry standards.

Critical Subsystems and Components

Production and sales of specialized, high-performance subsystems and individual components essential for satellite functionality, avionics, and other space and defense-grade equipment.

Technology and Patents

Monetization of proprietary intellectual property, including licensing of innovative technologies, software, and patented designs developed to advance space exploration and utilization.

Financials



Key Metrics & Momentum

Operating Leverage: Even at an early stage, Sidus has developed an expansive platform and technology portfolio while maintaining stable operating expenses

Poised for Growth: Third satellite launch in under a year, with programs like Lonestar indicating strong near- and long-term revenue potential

Strengthened Balance Sheet: Raised \$53MM in 2025, positioning Sidus to pursue high-impact market opportunities

Cost Efficiency: Total cost per satellite has dropped significantly; LizzieSat®-3 is nearly 50% more cost-efficient than LizzieSat®-1

Strategic Flexibility: Healthy cash position and low leverage equip Sidus to scale quickly into emerging national security and infrastructure initiatives

Sidus continues to strengthen its position through disciplined growth, demonstrated heritage, expanded contracts, and a vertically integrated model designed to scale with mission-critical demand.

	Twelve Months Ended	
	December 31, 2025	December 31, 2024
Revenues	\$3,383,878	\$4,672,646
Cost of Revenue	\$9,076,445	\$6,141,657
Gross Profit (Loss)	\$(5,692,567)	\$(1,469,011)
Total Operating Expenses	\$22,315,569	\$14,249,870
Other Income (Expenses)	\$(1,466,168)	\$(1,805,175)
Net Loss	\$(29,474,304)	\$(17,524,056)

Capitalization Table as of March 31, 2026	
Class A Stock	66,419,852
Class B Stock	100,000
Options (WAEP: \$11.58)	64,552
Warrants (WAEP: \$2.23)	3,981,127
Fully Diluted Shares Outstanding	70,565,531



Contact Us:

Investors Relations

Adarsh Parekh, Chief Financial Officer

+1 321.450.5633 (option 1)

Investor-relations@sidusspace.com

Transfer Agent

Pacific Stock Transfer Company

6725 Via Austi Pkwy Suite 300

Las Vegas, NV, USA 89119

+1 702.361.3033 x 111

