



MaxLinear Investor Presentation

October 2019

Disclaimer

Forward-Looking Statements

This presentation contains forward-looking statements within the meaning of Section 27A of the Securities Act of 1933, as amended, and Section 21E of the Securities Exchange Act of 1934, as amended. Forward-looking statements include, among others, statements concerning our future financial performance and operating results forecasts as well as trends and growth opportunities in our product markets, our product development initiatives, and our future prospects generally. These forward-looking statements involve known and unknown risks, uncertainties, and other factors that may cause actual results to be materially different from any future results expressed or implied by the forward-looking statements. Forward-looking statements are based on management's current, preliminary expectations and are subject to various risks and uncertainties. Risks and uncertainties affecting our business, operating results, financial condition, and stock price, include, among others, intense competition in our industry; our dependence on a limited number of customers for a substantial portion of our revenues; uncertainties concerning how end user markets for our products will develop; potential uncertainties arising from continued consolidation among cable television and satellite operators in our broadband target markets and continued consolidation among competitors within the semiconductor industry generally; our ability to develop and introduce new and enhanced products on a timely basis and achieve market acceptance of those products, particularly as we seek to expand outside of our historic markets; potential decreases in average selling prices for our products; risks relating to intellectual property protection and the prevalence of intellectual property litigation in our industry; the impact on our financial condition of the indebtedness arising from our acquisition of Exar; and our lack of long-term supply contracts and dependence on limited sources of supply. In addition to these risks and uncertainties, investors should review the risks and uncertainties contained under the caption "Risk Factors" in our filings with the Securities and Exchange Commission (SEC), including our most recent Annual Report on Form 10-K for the year ended December 31, 2018, which we filed with the SEC on February 5, 2019, and our Quarterly Report on Form 10-Q for the quarter ended September 30, 2019. Unless otherwise indicated herein, all forward looking statements are based on estimates, projections, and assumptions of MaxLinear as of the date of this presentation. These slides do not constitute confirmation or an update of previously provided guidance. MaxLinear is under no obligation (and expressly disclaims any such obligation) to update or revise any forward-looking statements whether as a result of new information, future events, or otherwise.

Non-GAAP Financial Measures

This communication may contain certain non-GAAP financial measures, which MaxLinear management believes are useful to investors and reflect how management measures MaxLinear's business. Further detail and reconciliations between the non-GAAP financial measures and the GAAP financial measures are available on the Investor Relations section of MaxLinear website as part of its published financial results press release. Because of the inherent uncertainty associated with our ability to project future charges, particularly those related to stock-based compensation and its related tax effects as well as potential impairments, we do not provide reconciliations to forward-looking non-GAAP financial information.



MaxLinear

Pioneer of Low Power, CMOS RF and Mixed-Signal Digital SoCs

Founded 2003	NYSE MXL	Patents* 1400+
739 Employees*	~67% Engineers*	1B+ Units Delivered

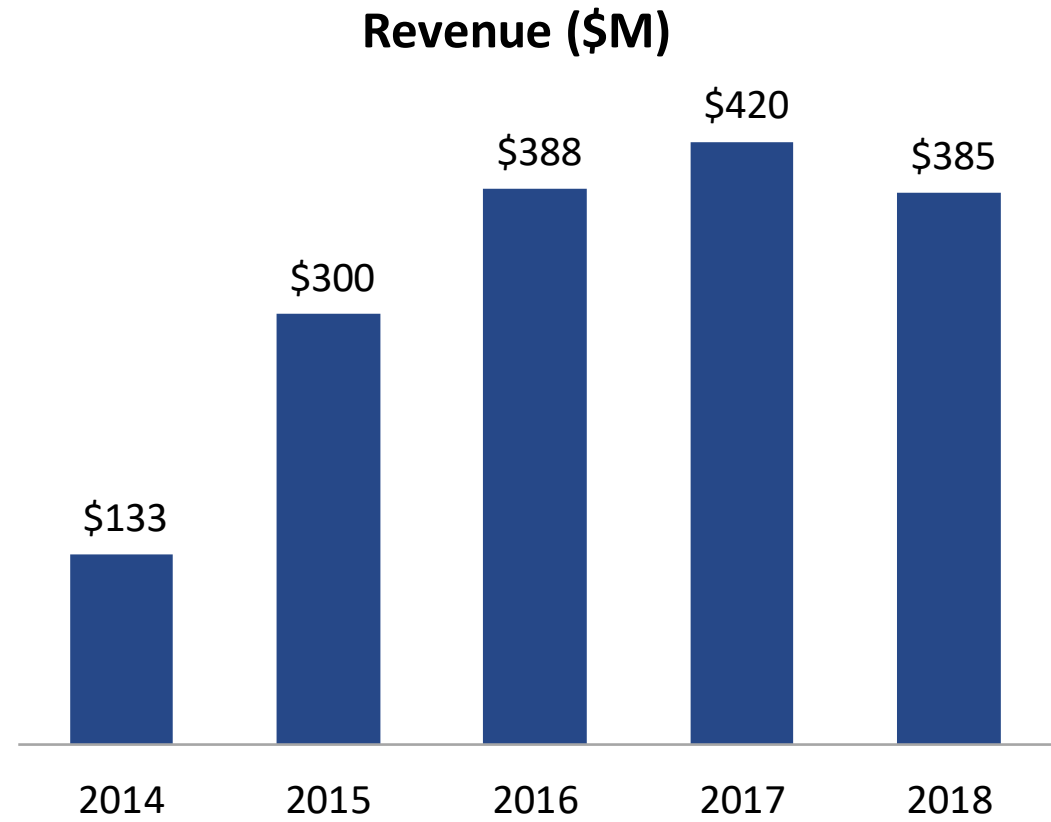

*As of December 31, 2018



Exploding Data & Traffic Demand Fatter & Faster Data Pipes

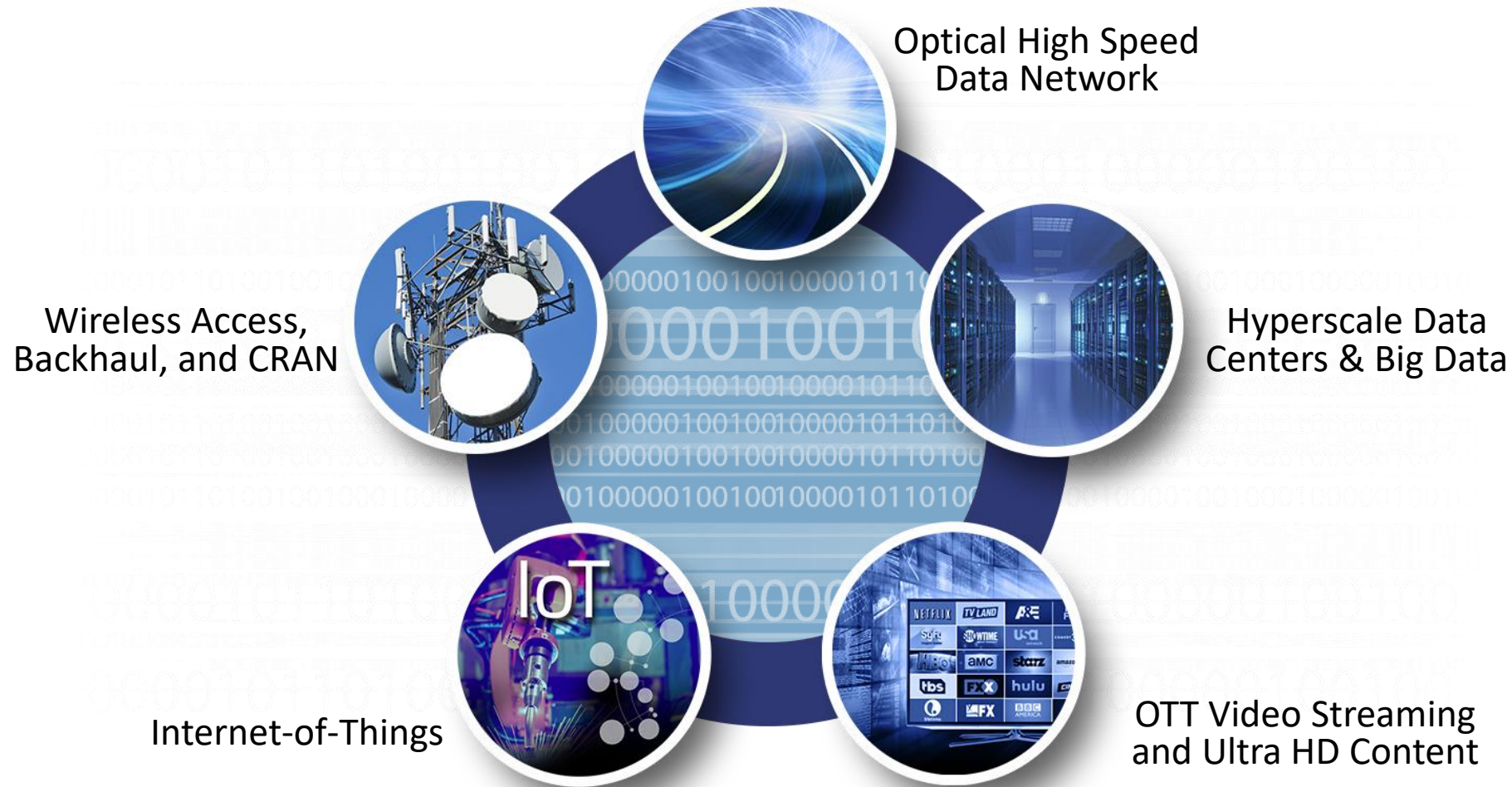

We Solve Communication Network Bottlenecks

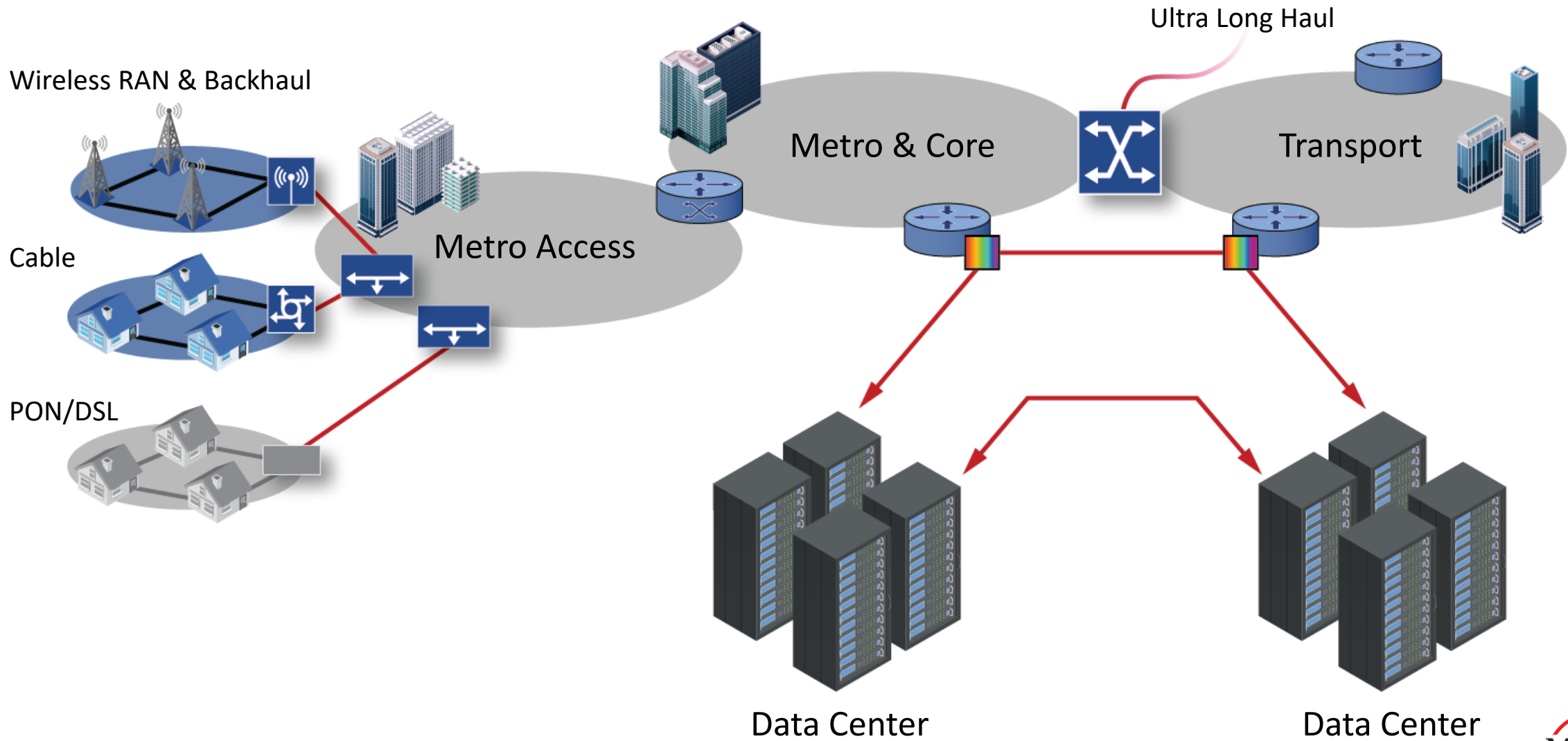

With End-to-End Communication Network Solutions

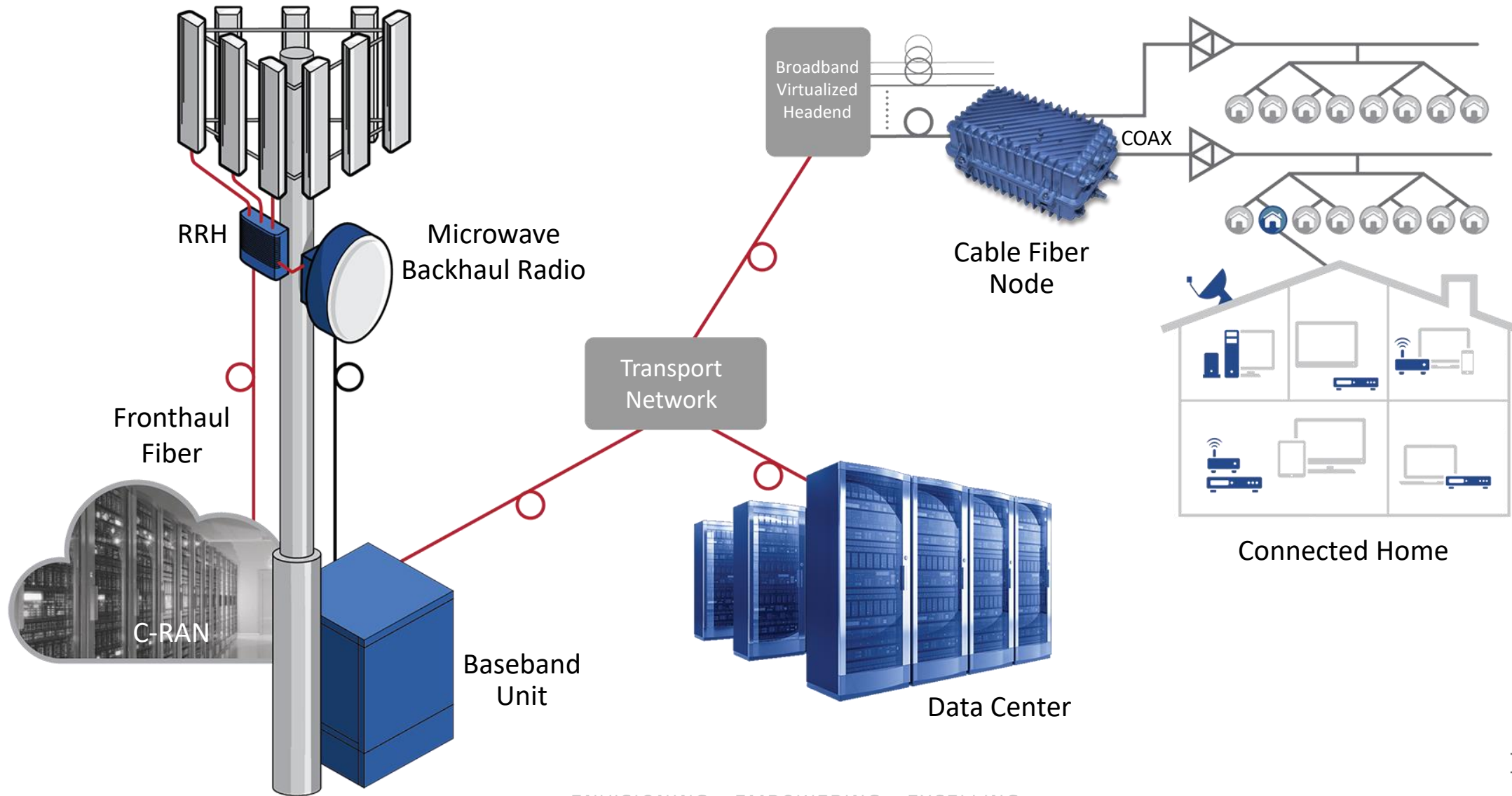

Our Core Technology Platform Scales Across Multiple Communications End Markets

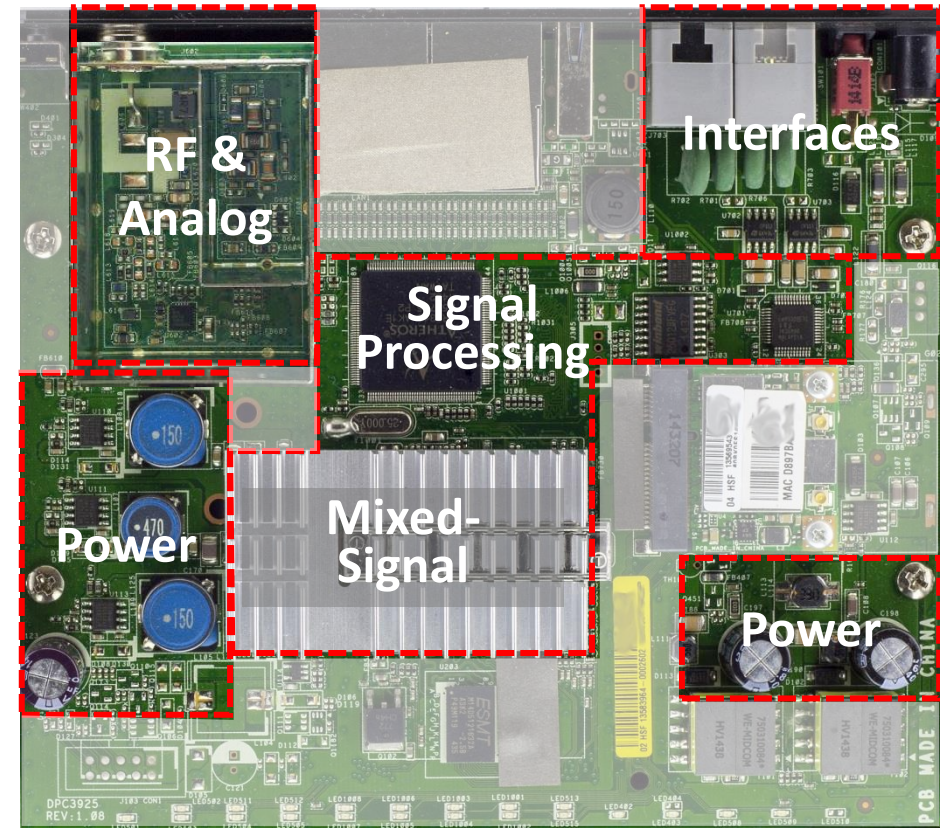
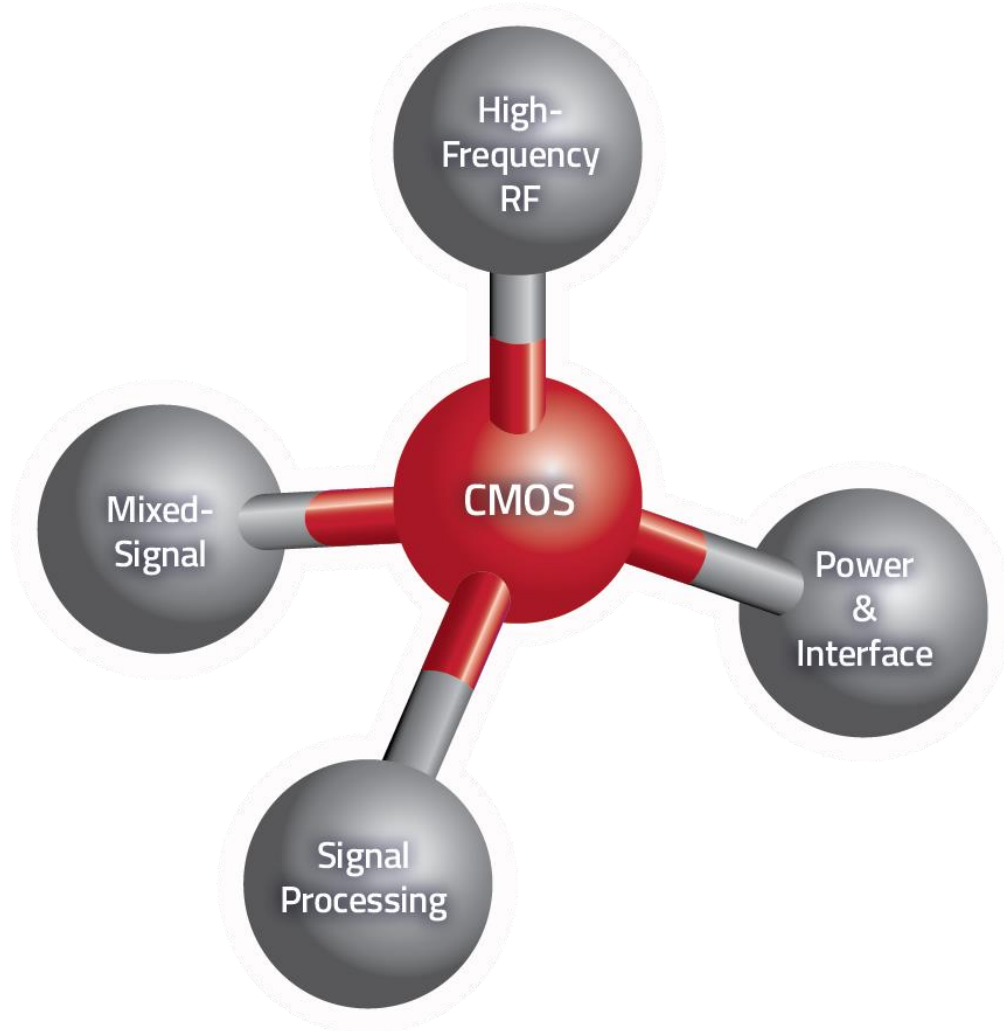

Typical Communication Link

Expanding Addressable Markets

Through Organic Growth and Strategic Acquisitions

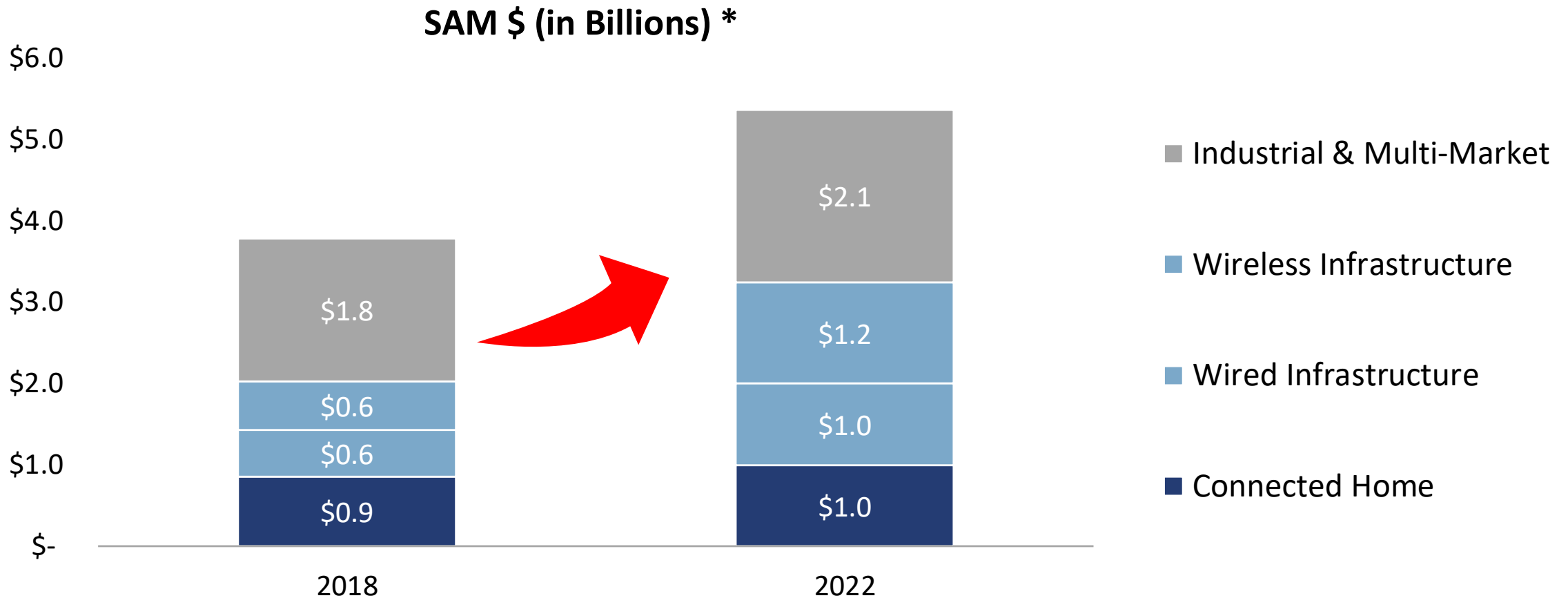

*All data based on a combination of industry research reports and management estimates

Diversified End Market Portfolio

Connected Home



Industrial / Multi-Market

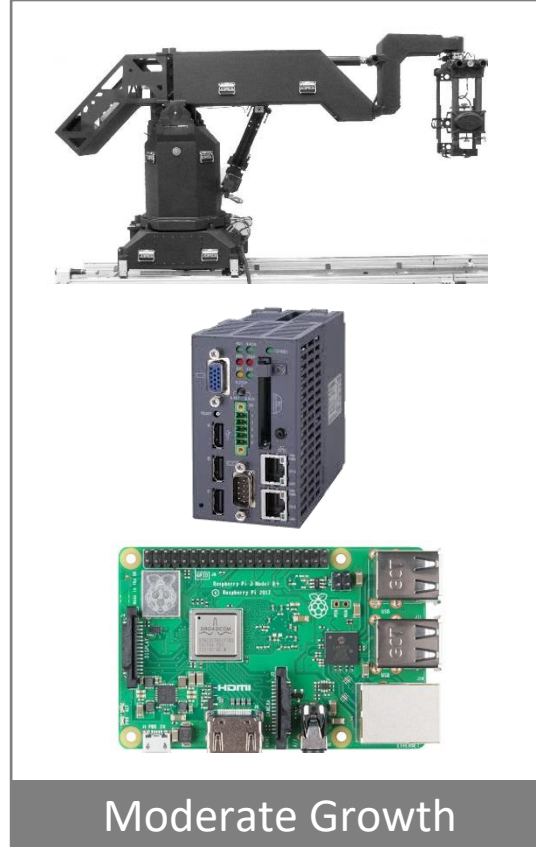

Infrastructure



Connected Home

Comprehensive Solutions Enabling Bandwidth Expansion into and throughout the Home

In-Home Connectivity



Cable Broadband Data



Satellite Video Gateways & ODU's



Connected Home

Stable, and Highly Profitable Revenue Platform

SAM \$ (in millions)*

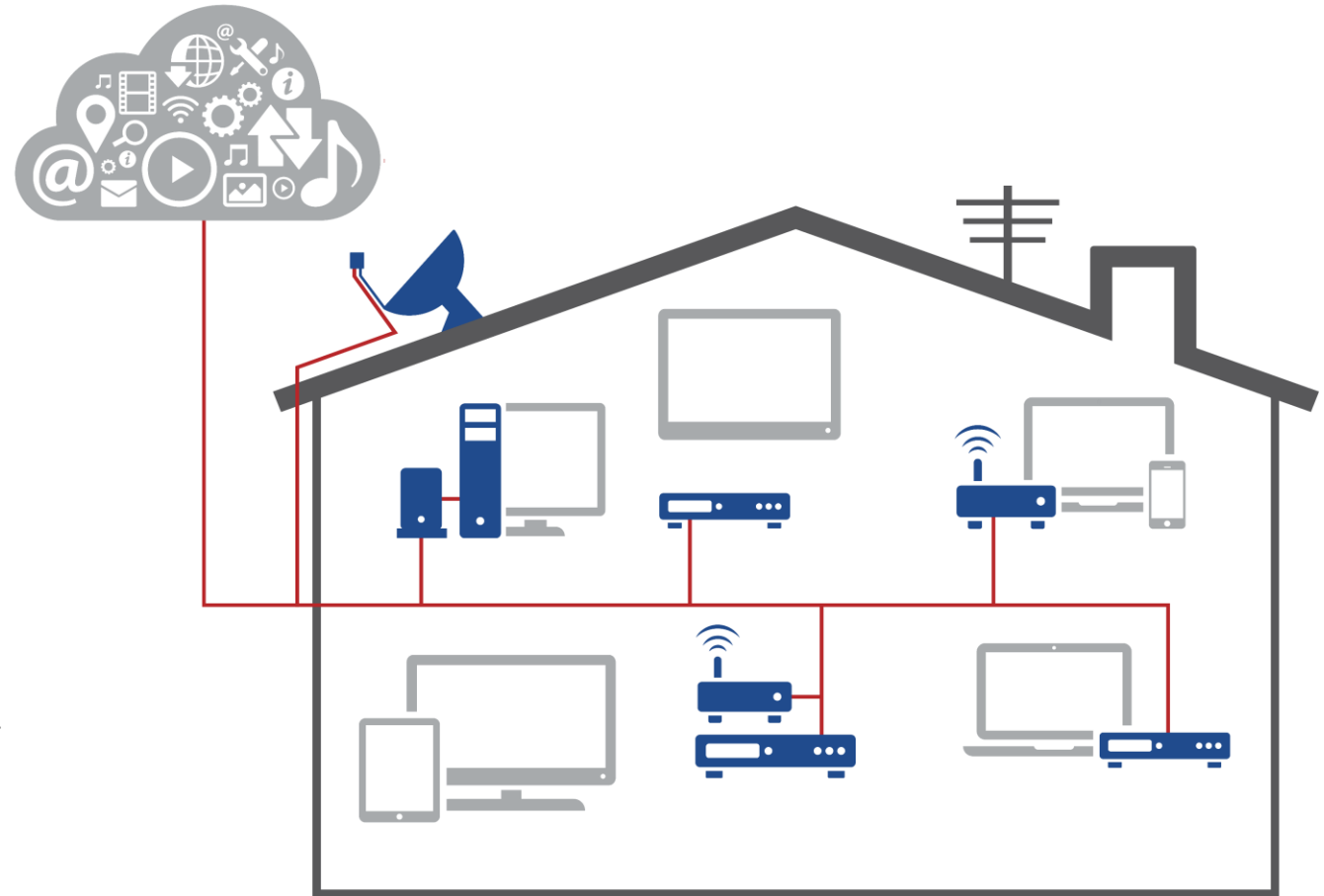
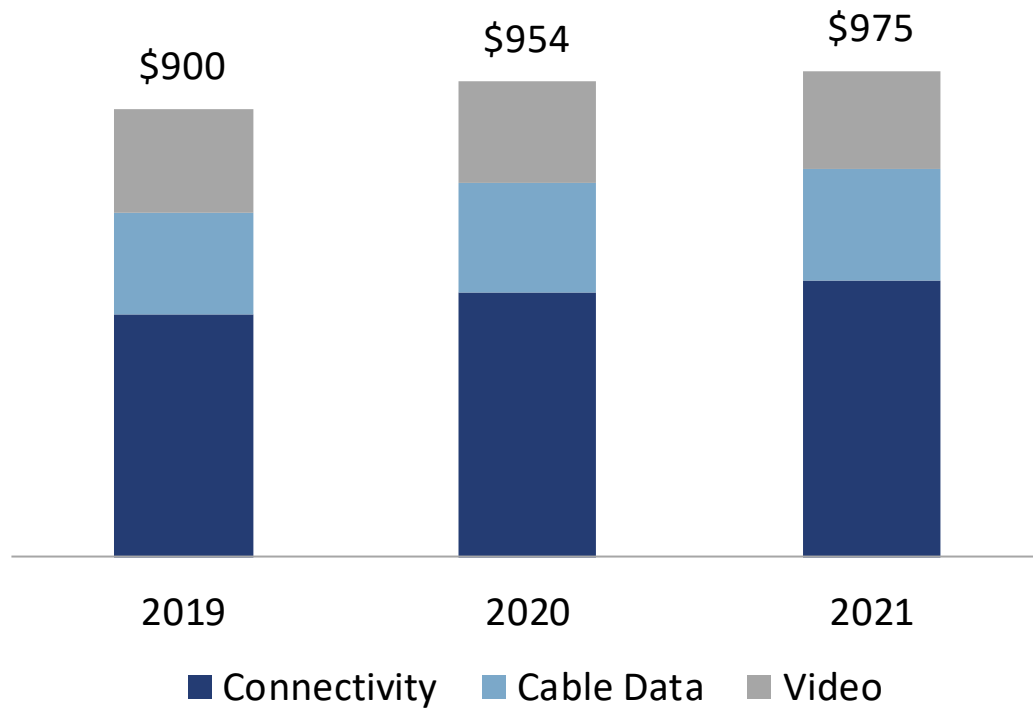

*All data based on a combination of industry research reports and management estimates

Cable Access

DOCSIS Front Ends & PGA



Leader in CMOS RF Front Ends for Cable
Data Platforms over 3 Generations

100+ Million Units in Operation

Lowest Power Consumption CMOS PGAs
Expands MaxLinear Footprint

Leading the Transition to Full Duplex
DOCSIS3.1 Systems

In-Home Connectivity

Wireline Multi-Gigabit/s Data Distribution Using MoCA & G.hn

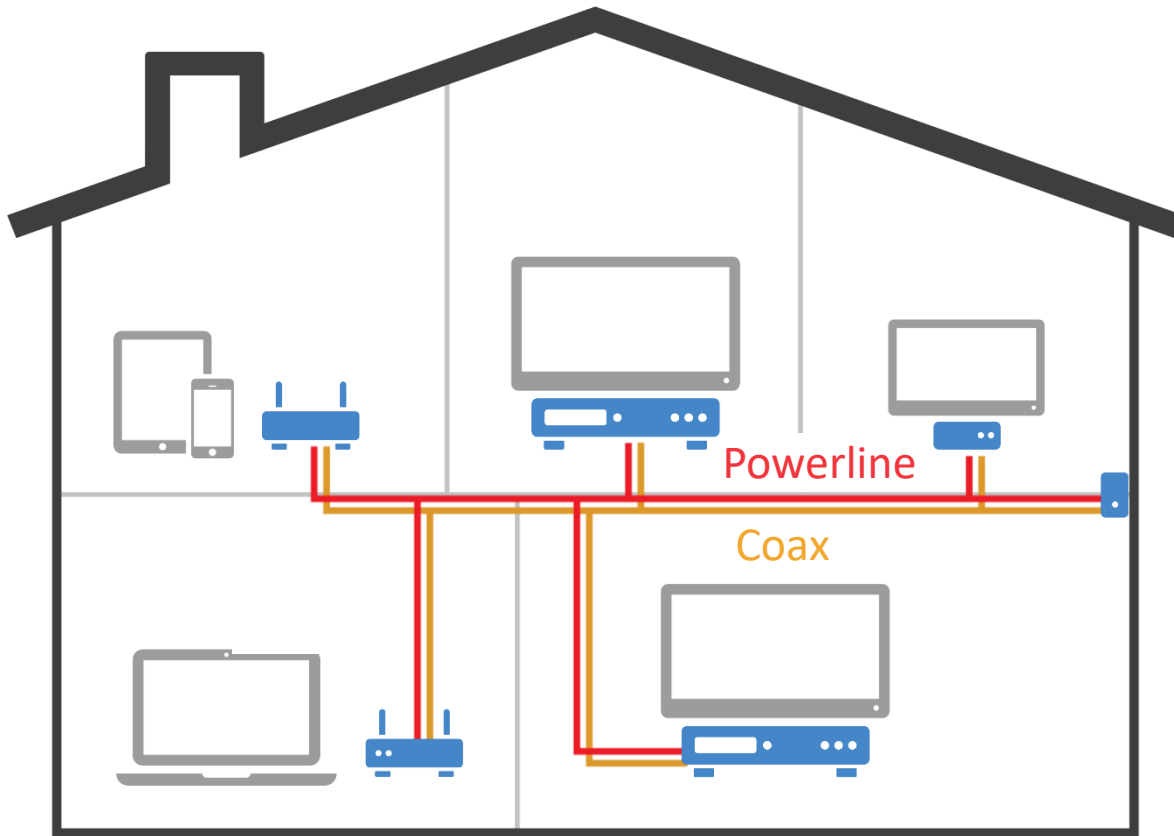

Multi-Gigabit Any-Wire Portfolio
(Coaxial Cable, or Powerline)

Solves Wi-Fi Coverage, Power and
Throughput Issues

Improves Reliability of On Demand
and OTT Streaming Video

Lowers CAPEX by Enabling
Gateway/Client STB Architecture

Wireless Infrastructure

5G Build-Out Enables 10X Data Speeds versus 4G

Access



Microwave & mm-Wave
Backhaul & Fronthaul



NOKIA



Optical Fronthaul



NEC



4G & 5G Wireless Infrastructure

Wireless Access, Wireless Backhaul, and Optical Fronthaul

Wireless SAM (in millions)*

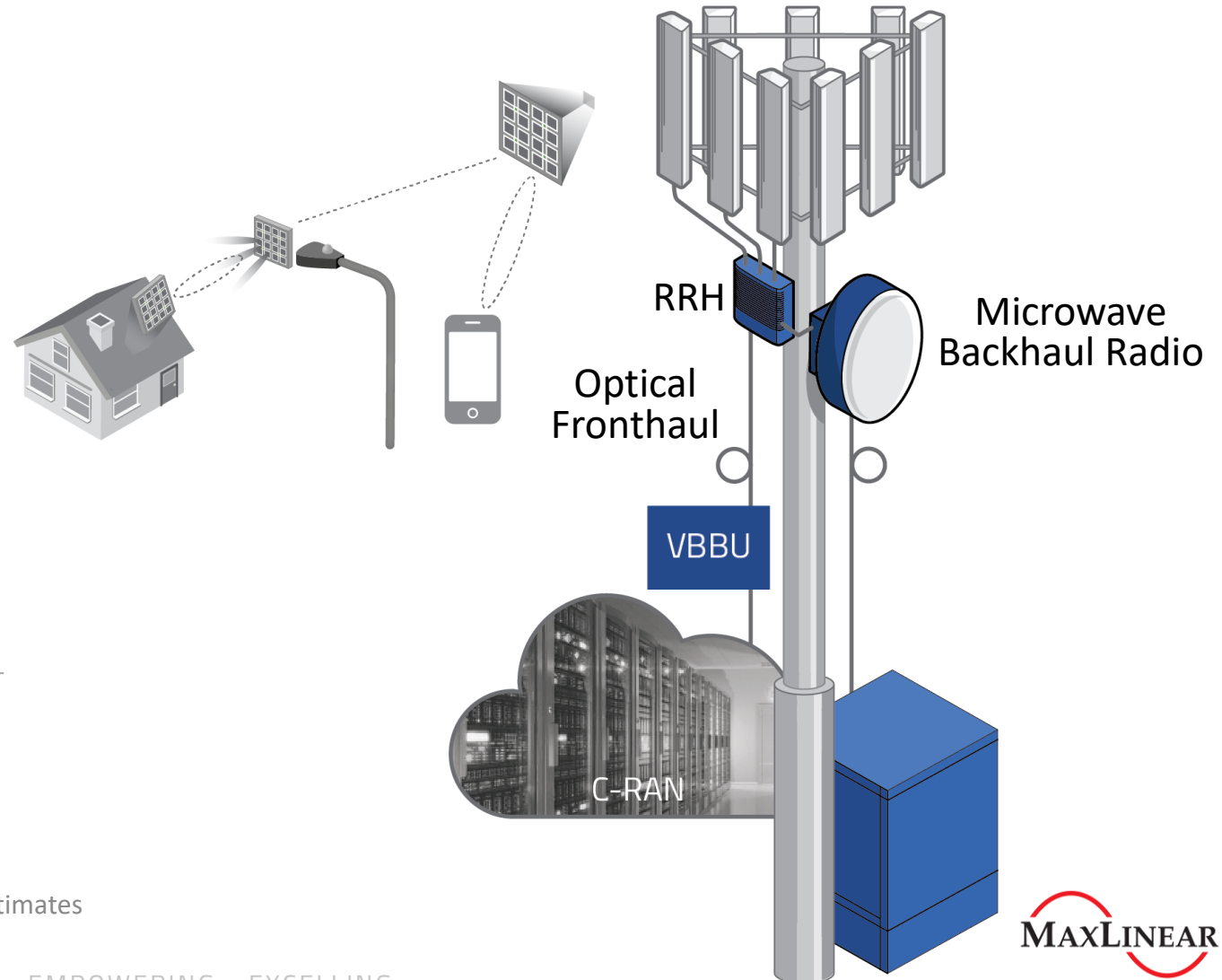
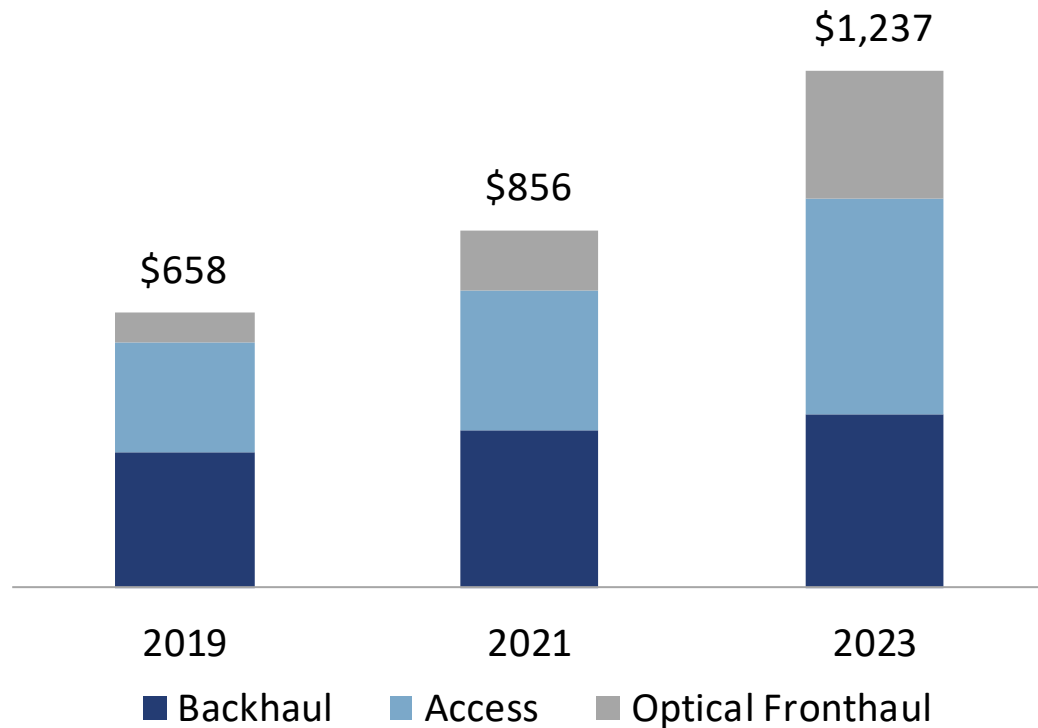

*All data based on a combination of industry research reports and management estimates

5G Wireless Access – Massive MIMO Transceivers

Active Antenna Systems 10x Data Rates

4T4R Transceiver Units (in millions) *

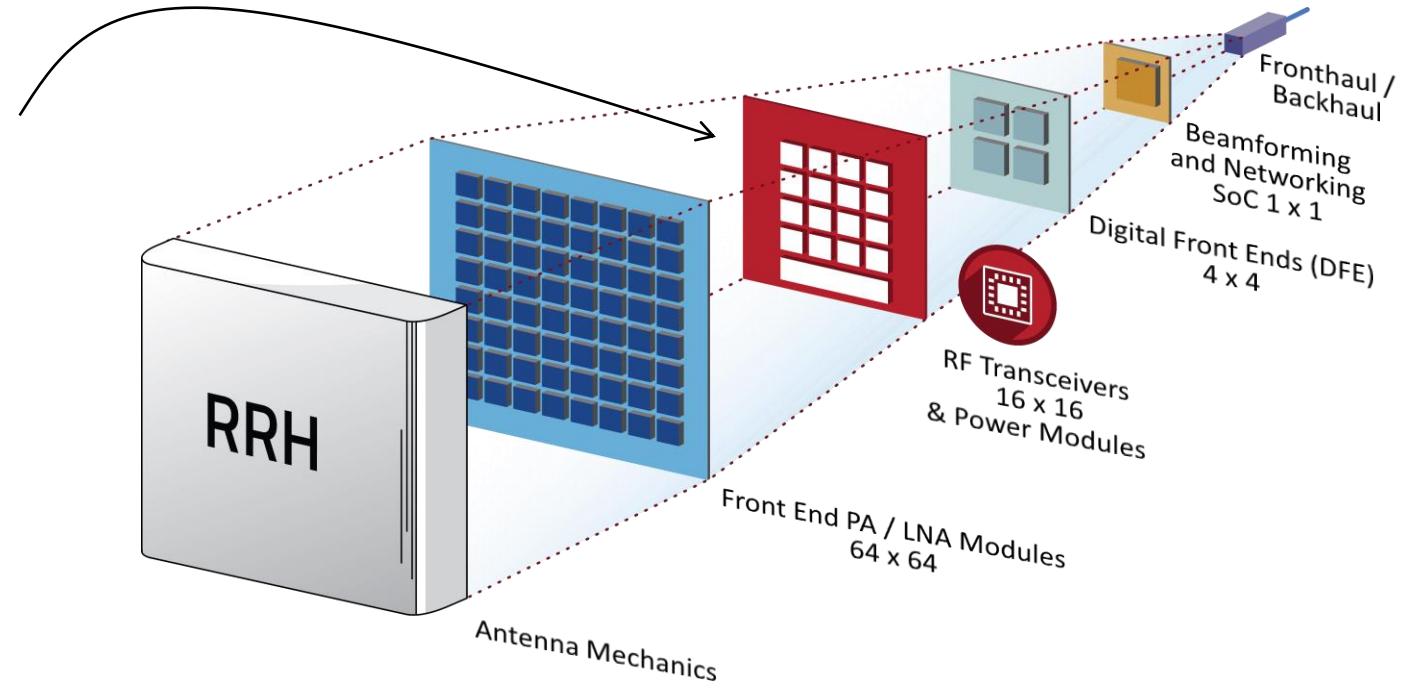
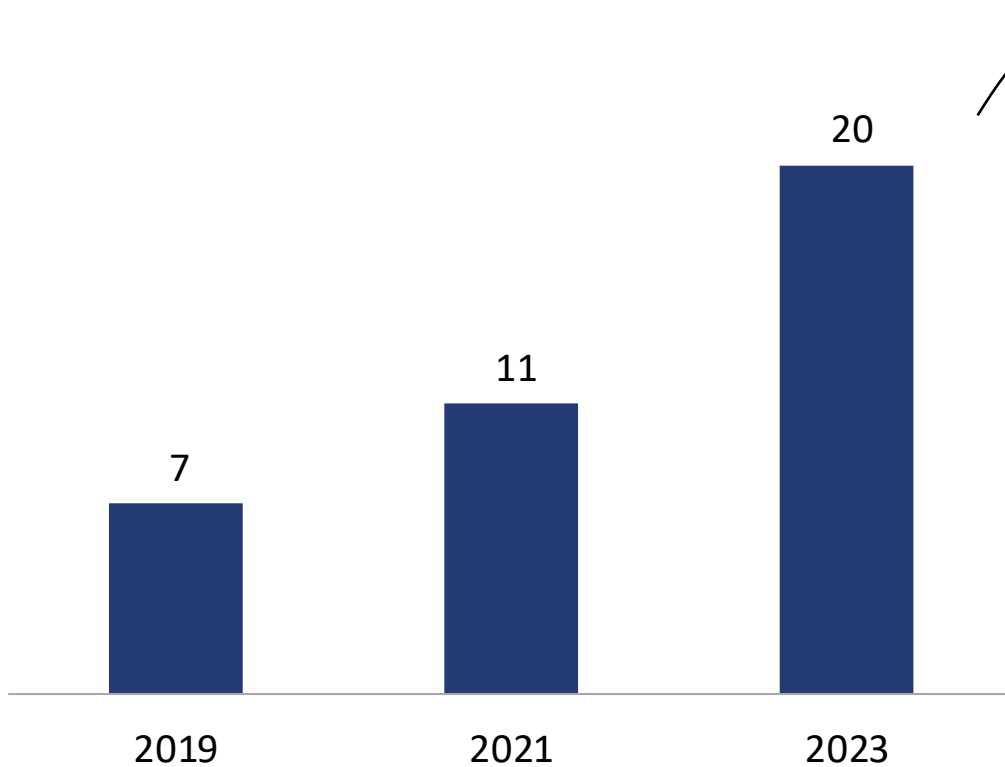

*All data based on a combination of industry research reports and management estimates

Wireless Backhaul & Fronthaul Microwave & mm-Wave

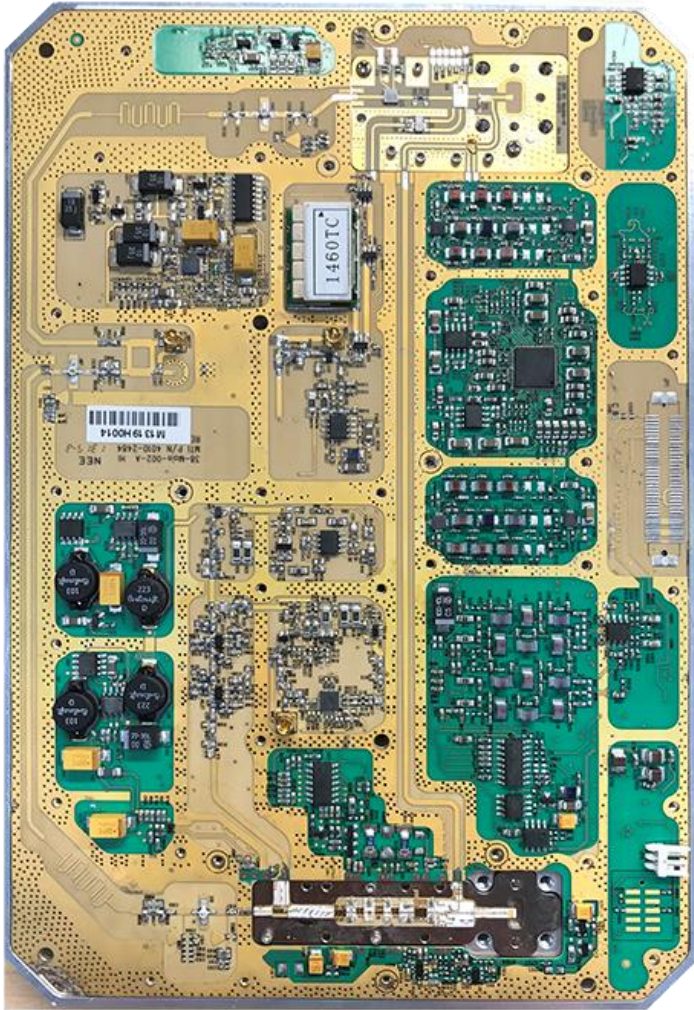

Competition



MaxLinear

Only Single-Chip RF Transceiver Solution (CMOS) for Entire Frequency Spectrum of 6-to-44GHz

Reduced Complexity = Single SKU for all Frequency Bands; Lowest Power

Industry's Only Full System Solution (up to 20Gbps data rates) = RF + Baseband Modem

Wired Infrastructure

Comprehensive Solutions Enabling Bandwidth Expansion

Data Center Optical Fiber



Optical Metro/Long Haul Fiber



Last Mile Access



Wired Infrastructure

Data Center Fiber Optics, Last Mile Access, & Metro/Long Haul Fiber

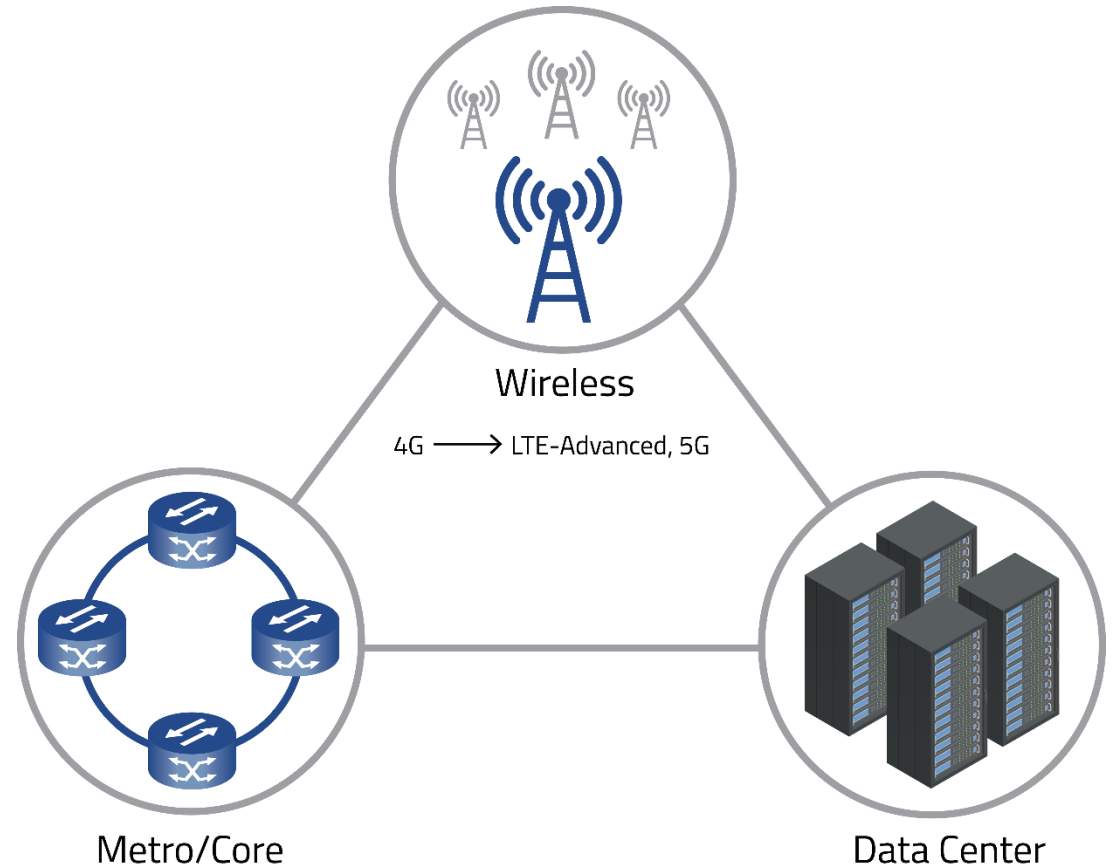
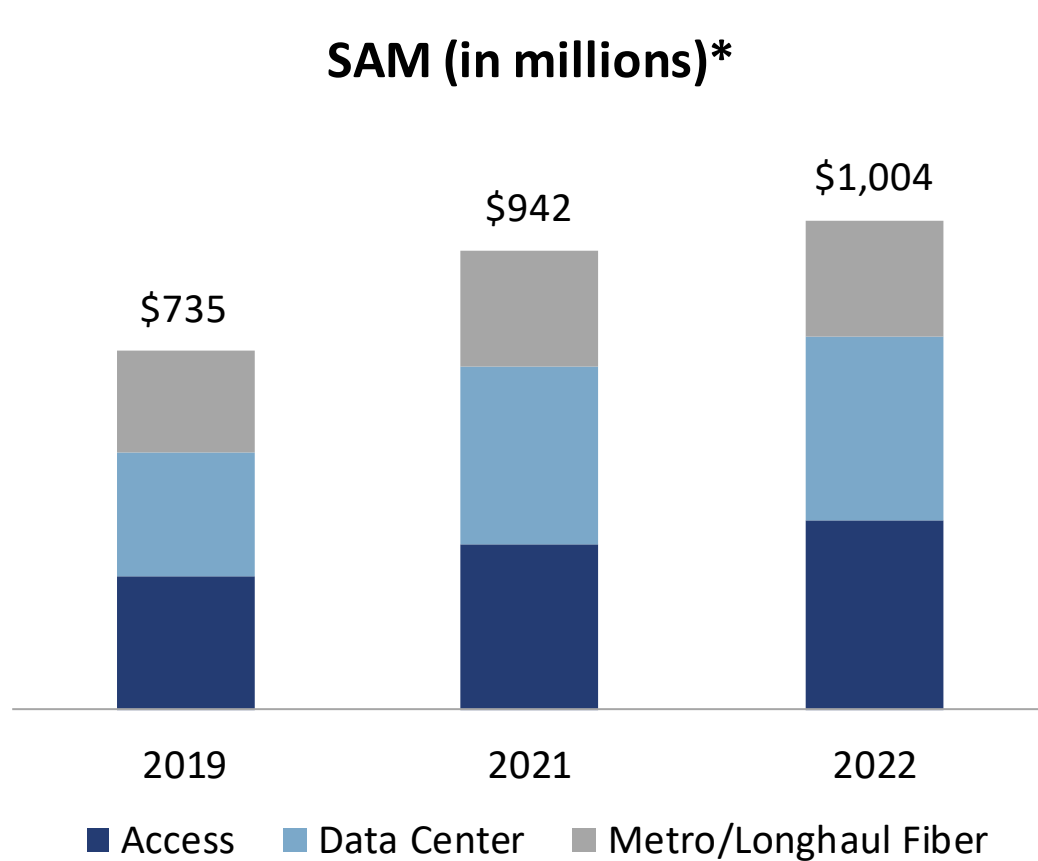

*All data based on a combination of industry research reports and management estimates

Data Center Fiber

PAM4 DSP for 400Gbps Single-Lambda Optics Based Interconnects

400G Ethernet Port Count (in millions)*

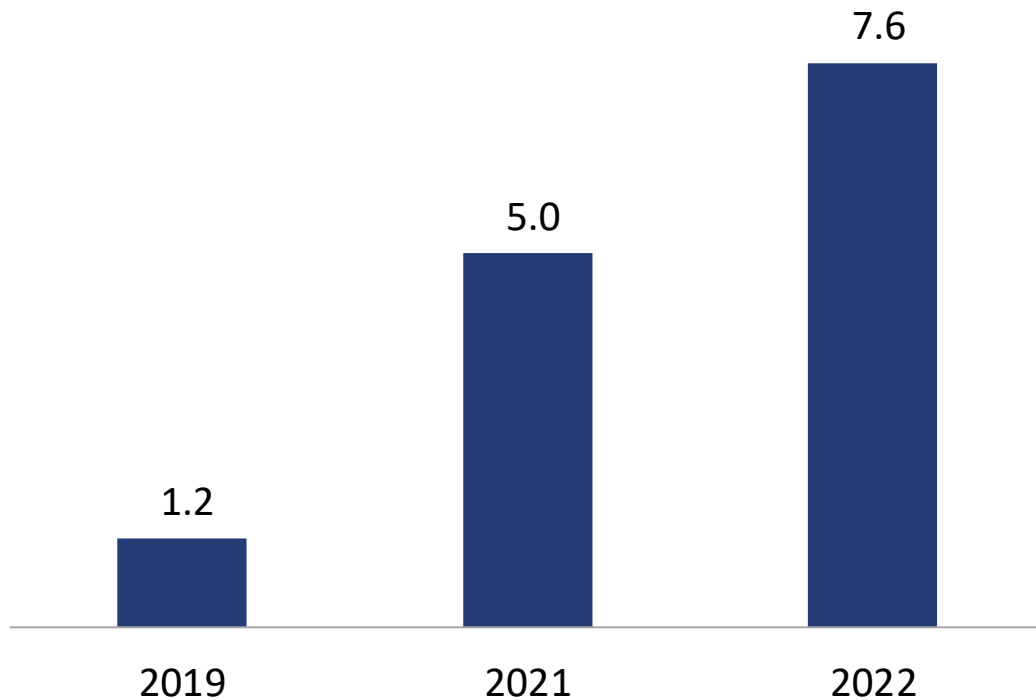

QSFPDD



18.35 x 89.4 x 8.5

OSFP



22.5x107.8x13.0

CFP8



40x102x9.5

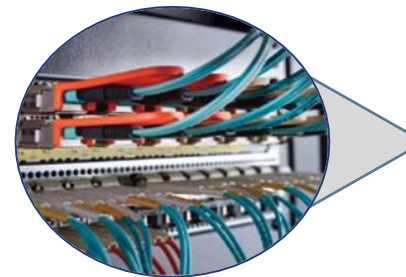

*All data based on a combination of industry research reports and management estimates

Telluride PAM4 Single-Lambda SoC Platform

4x100G, 2x100G and 1x100G DC Optical Interconnects

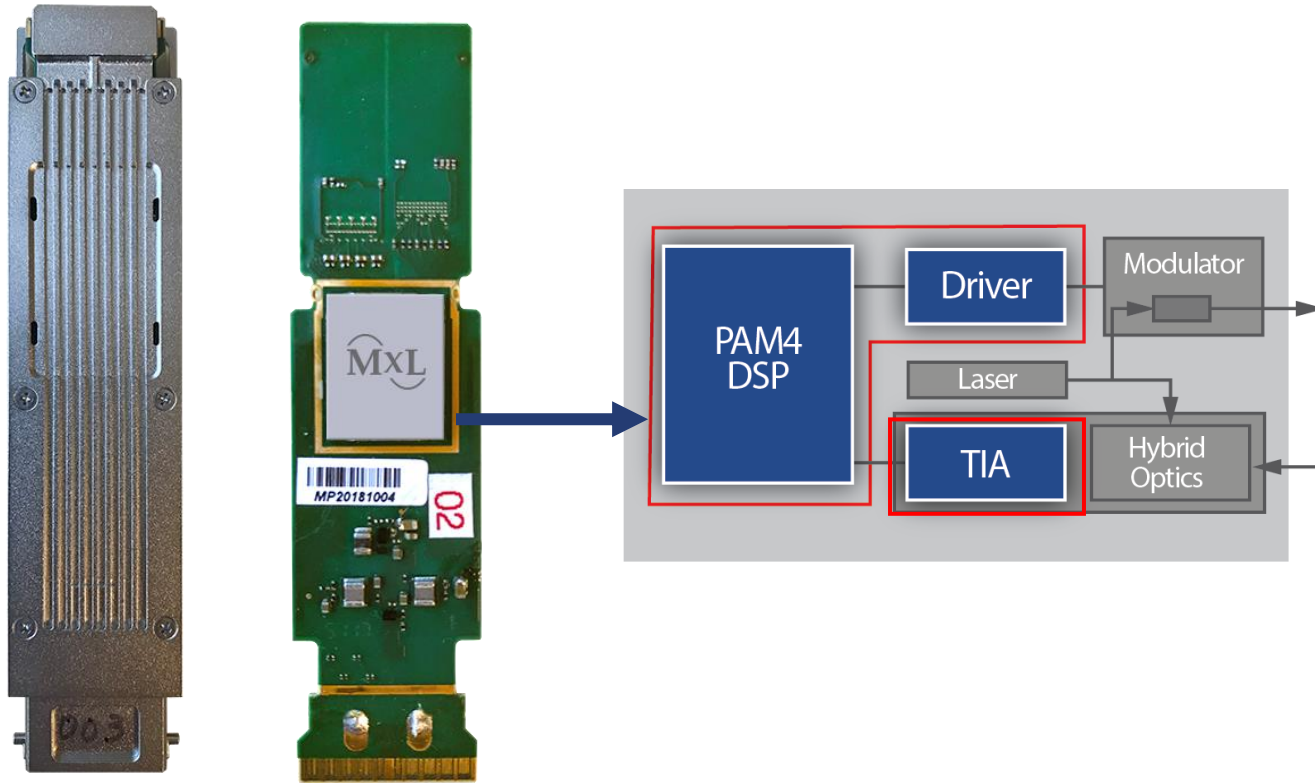

1st 400G Data Center Transceiver Chipset
with Integrated Laser Driver

Supports 100/200/400Gbps

Enables <10W 400G Solution

Only Supplier with Integrated PAM4 DSP
and Laser Driver + TIA System Solution

Industrial & Multi-Market

Power Management and Interface Products

**Single-Board-Computer
Industrial Process Control**



Audio/Video Equipment



**Building/Factory
Automation**



Point-of Sale



SIEMENS

ingenico
GROUP



Schneider
Electric



Industrial & Multi-Market

Expansive Interface and Growing Power Management Portfolio
Addressing a Large Stable Market

2018 SAM (in millions)*

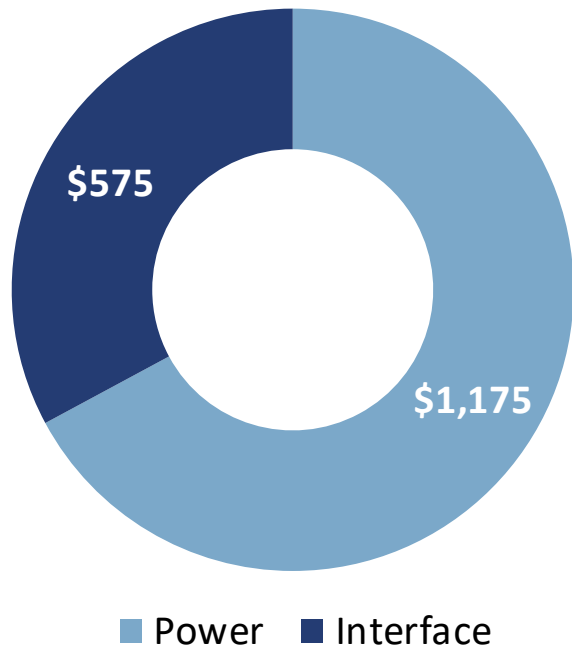

Industrial / Multi-Market

POS Point-of-Sale, Diesel Trains, Motor Control, Drones, IoT Sensor Nodes, ATM, Gas Pumps, A/V Equipment, Docking Stations, MRI, Ultrasound and Patient Monitors, Motion Control & Robotics, Industrial Control Systems, Building Automation, HVAC Network, Machinery, Single Board Computers, IPC

Vast Array of Stable Applications with >15,000 Existing Customers

*All data based on a combination of industry research reports and management estimates

Optimized Power Management ICs Provide Highly Efficient Power Supply Rails for FPGAs and SoCs

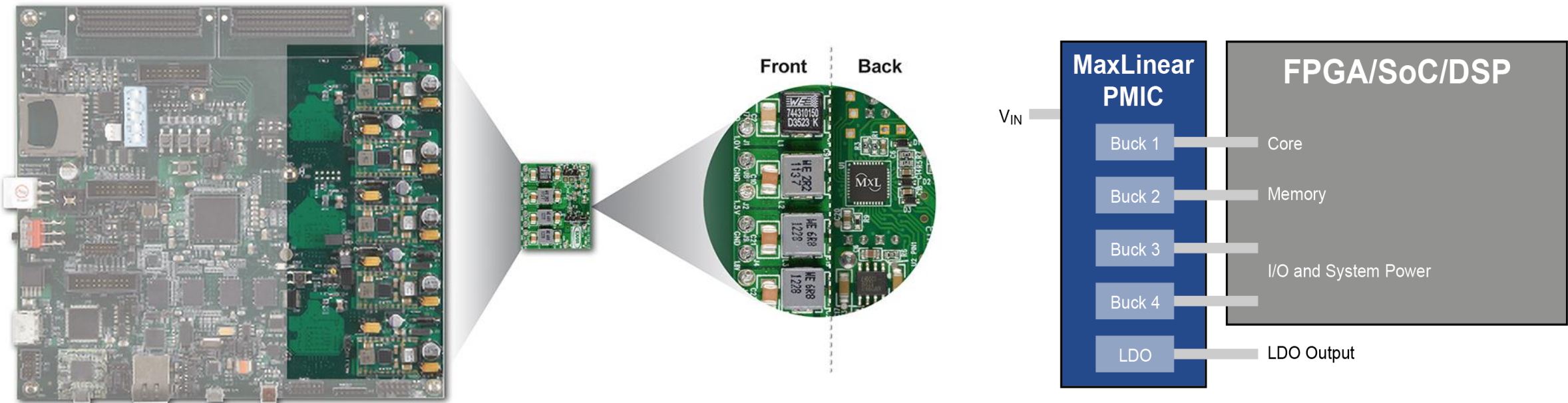

**Highly Integrated Universal PMICs
Reduce Footprint by 88%**

**Integrated Bucks Provide System,
Memory, I/O and Core Power**

New Infrastructure Products Driving Long Term Growth

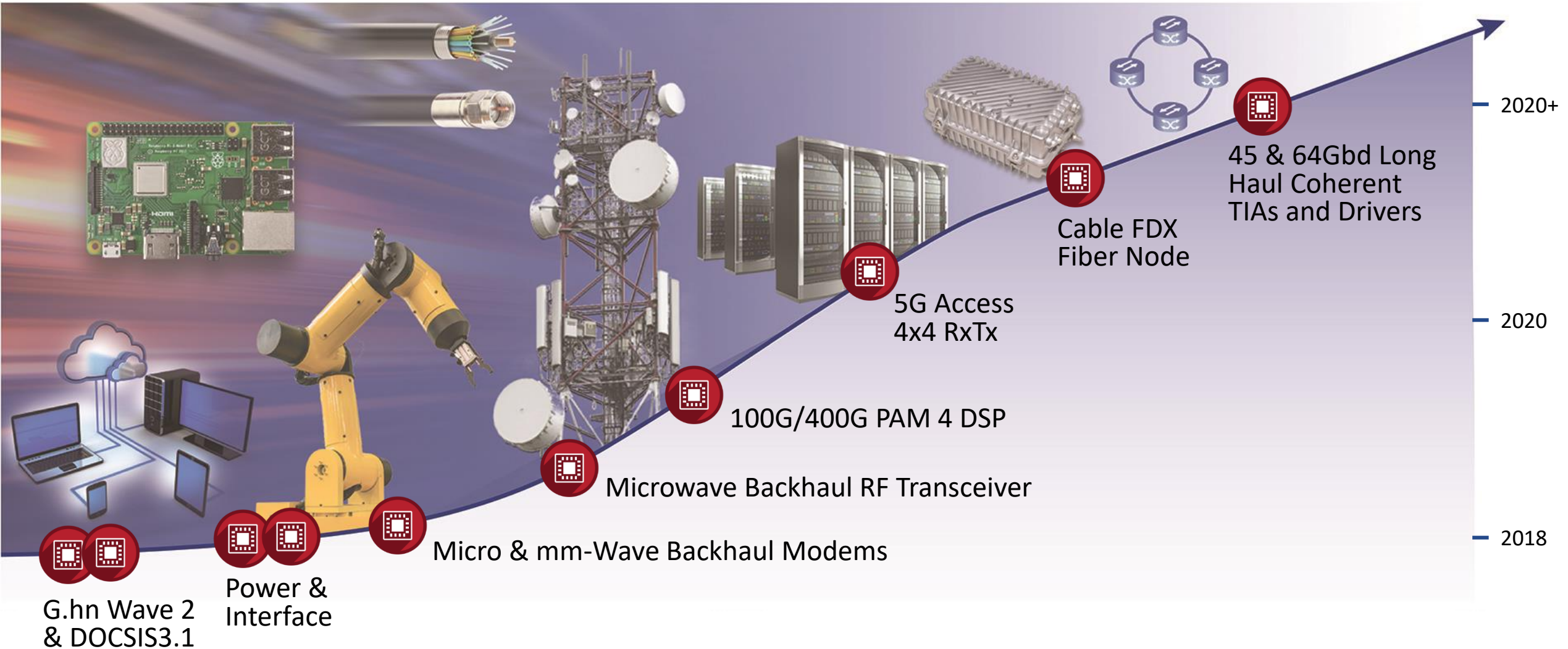



Financial Overview

Quarterly Non-GAAP Financial Model

NON-GAAP	Q1 2018 Results	Q2 2018 Results	Q3 2018 Results	Q4 2018 Results	Q1 2019 Results	Q2 2019 Results	Q3 2019 Results	Q4 2019 Guidance
Revenue	\$110.8M	\$101.5M	\$85.M	\$87.6M	\$84.6M	\$82.5M	\$80.0M	\$67M - \$73M
Gross Margin	64.9%	64.6%	62.5%	62.7%	63.5%	63.9%	63.1%	63.5% - 64.0%
Operating Expenses	\$39M	\$37M	\$36M	\$37M	\$36M	\$33M	\$31M	\$29.5M - \$30.5M
OpEx % of Revenue	35.5%	36.6%	41.8%	41.9%	42.2%	39.7%	38.4%	40% - 46%
Operating Income	\$33M	\$28M	\$18M	\$18M	\$18M	\$20M	\$20M	\$12M to \$17M
Operating Margin	29.4%	28.0%	20.7%	20.8%	21.3%	24.1%	24.7%	18% to 24%

Notes:

- Guidance as of October 24, 2019
- Interest and other expense related to the 7 year \$425M Term Loan B is expected to be \$2.6M to \$2.7M in Q4 2019
- NON-GAAP tax rate is expected to be 5% in Q4 2019



Quarterly GAAP Financial Model

GAAP	Q1 2018 Results	Q2 2018 Results	Q3 2018 Results	Q4 2018 Results	Q1 2019 Results	Q2 2019 Results	Q3 2019 Results	Q4 2019 Guidance
Revenue	\$110.8M	\$101.5M	\$85.M	\$87.6M	\$84.6M	\$82.5M	\$80.0M	\$67M - \$73M
Gross Margin	56.5%	55.5%	51.6%	52.4%	53.3%	53.4%	52.4%	52.0% - 52.5%
Operating Expenses	\$58M	\$57M	\$56M	\$57M	\$53M	\$47M	\$45M	\$44.0M - \$44.5M
OpEx % of Revenue	52.5%	55.7%	66.4%	64.6%	62.5%	57.0%	56.5%	60% - 66%
Operating Income	\$4M	\$0M	-\$13M	-\$11M	-\$8M	-\$3M	-\$3M	-\$6M to -\$10M
Operating Margin	4.0%	-0.2%	-14.8%	-12.2%	-9.3%	-3.6%	-4.2%	-8% to -14%

Notes:

- Guidance as of October 24, 2019
- Interest and other expense related to the 7 year \$425M Term Loan B is expected to be \$2.6M to \$2.7M in Q4 2019
- GAAP tax expense is expected to be approximately zero in Q4 2019



Key Take-Aways

- Technology Pioneer in CMOS Broadband RF & Mixed-Signal
- Rapid Growth & Profitability
- High Gross Margins and Increased Operating Leverage Enables Strong Free Cash Flow Generation
- Growth Strategy – Expand Footprint in Existing Platforms, and Grow Into High Value End Markets in Wireline and Wireless Infrastructure and Industrial and Multi-markets
- Unique R&D Intensity and Strong Intellectual Property Portfolio of Approx. 1,400+ Granted/Pending Patents



MAXLINEAR



Thank You

Annual Non-GAAP Financial Model

NON - GAAP	2014	2015	2016	2017	2018
Revenue (M)	\$133	\$300	\$388	\$420	\$385
Gross Margin	62%	58%	63%	63%	64%
R&D	34%	22%	20%	21%	25%
SG&A	18%	13%	11%	13%	14%
Impairment & Restructuring Charges	0%	0%	0%	0%	0%
Operating Margin	10%	24%	32%	29%	25%

Note: Fiscal year-end is December 31.

Annual GAAP Financial Model

GAAP	2014	2015	2016	2017	2018
Revenue (M)	\$133	\$300	\$388	\$420	\$385
Gross Margin	62%	52%	59%	49%	54%
R&D	43%	28%	25%	27%	31%
SG&A	26%	26%	17%	25%	26%
Impairment & Restructuring Charges	0%	12%	1%	3%	2%
Operating Margin	-7%	-15%	16%	-5%	-5%

Note: Fiscal year-end is December 31.